

prēmoulē

V285WT  
Jazz Silk  
Textured

R105S - White - Super Matte

## THERMOPLASTIC DOORS AND COMPONENTS

Custom program



## **TABLE OF CONTENTS**

---

**01** DISCOVER OUR THERMOPLASTIC DOOR OPTIONS

### **Door models**

---

**04** SHAKER

**14** SLAB

**16** STANDARD

**30** SPECIAL

### **Customized touch**

---

**35** FRAME AND MULLION DOORS

**37** PANELS, MOULDINGS AND ACCESSORIES

**47** COLORS AND FINISHES

### **Information**

---

**45** TECHNICAL SPECIFICATIONS

**53** WARRANTY



# DISCOVER OUR THERMOPLASTIC DOOR OPTIONS

## 1. SELECT THE PRODUCT

**2XXX** = Door

**4XXX** = Standard frame and mullion doors

**6XXX** = Special frame and mullion doors

**3XXX** = Drawer front

**5XXX** = Panels, mouldings and accessories

## 2. SELECT THE DESIGN

**1** Square

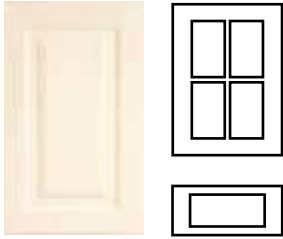

**2** Arch

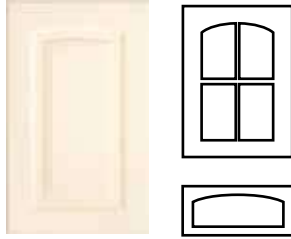

**3** Cathedral

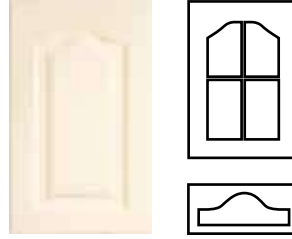

**4** Half Circle

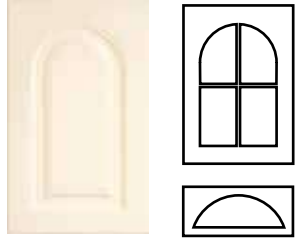

## 3. SELECT THE INTERIOR PROFILE



# DISCOVER OUR THERMOPLASTIC DOOR OPTIONS

## 4. SELECT THE EXTERIOR PROFILE

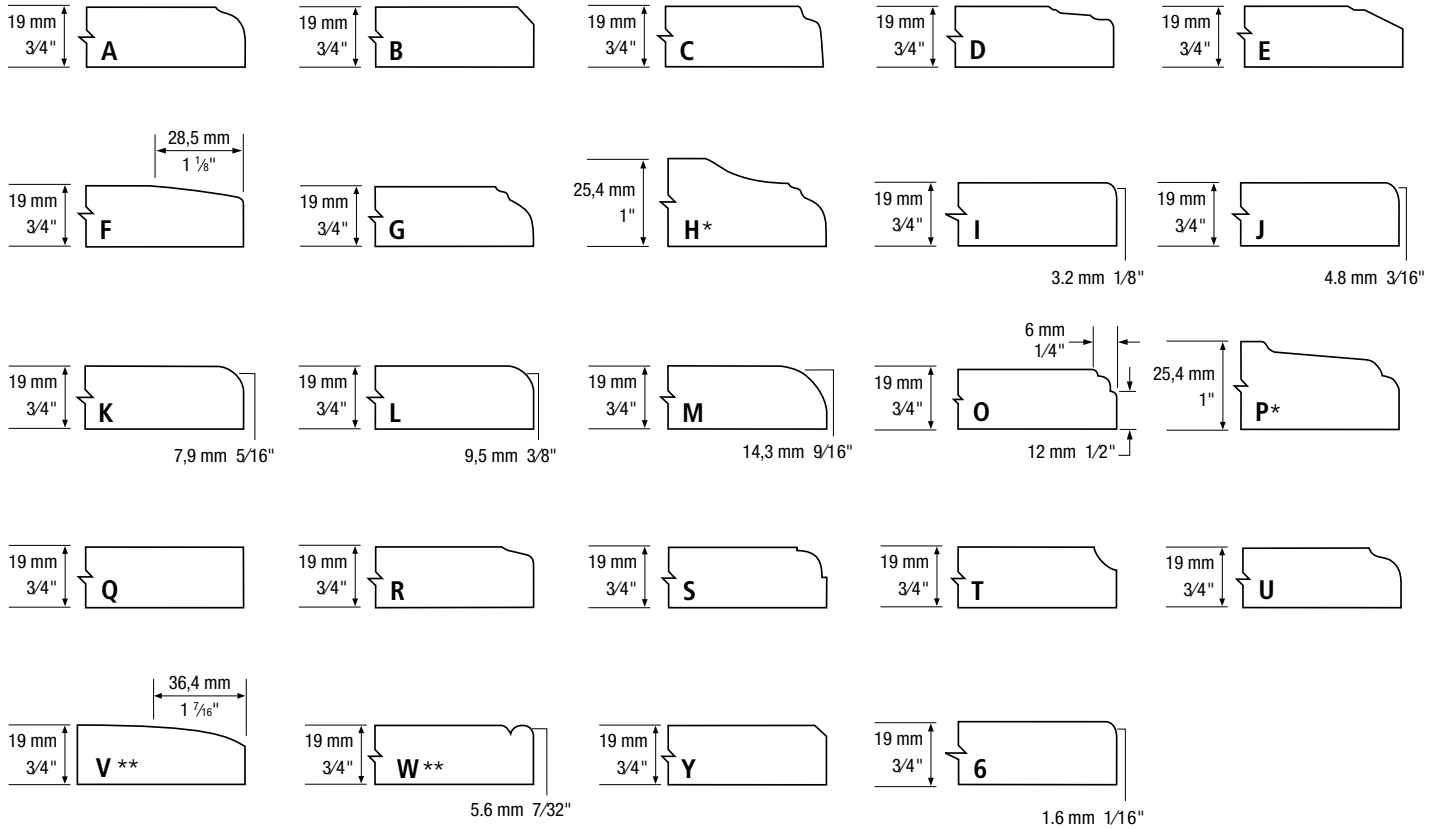

\* Exterior profiles H and P available with MDF 1" only.

\*\* Exterior profiles V and W available with an upcharge.

## 5. THE RESULT

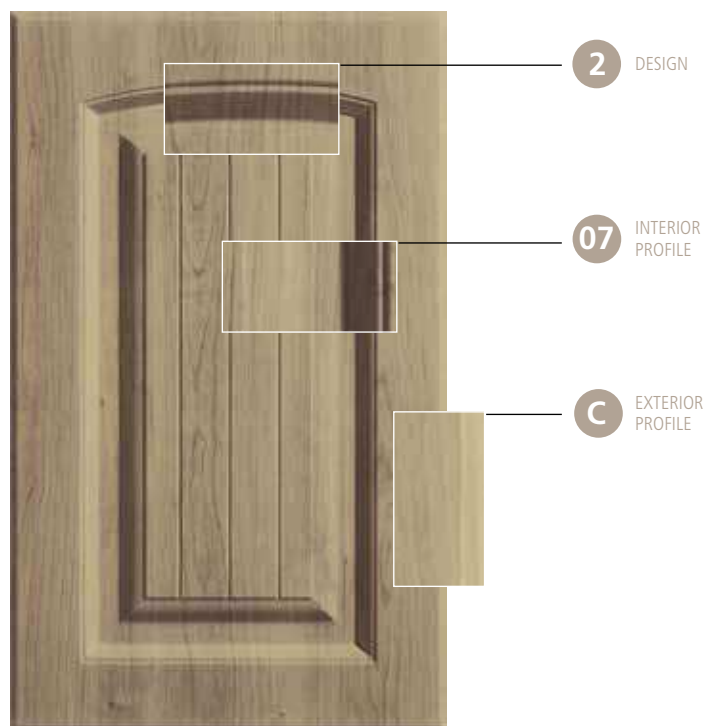

Model **2207**

Color: F435WT

Vertical grooves optional. Details on page 33.



R80S - CELESTINE - SATIN

## DOOR MODELS

SHAKER  
SLAB  
STANDARD  
SPECIAL

# SHAKER MODELS

## OPTION:

- See availability of same color melamine back, pages 47-48.

## SERIES 41 Category 6



Model **2141**  
Color: R82S

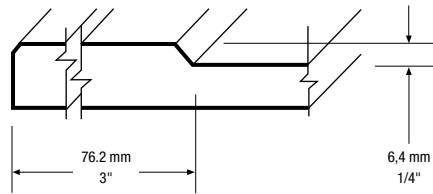

Model **3141**  
Regular rails

Model **3141**  
Reduced rails

### Minimum dimensions

#### Doors and drawer fronts (Height x Width)

Model	mm	inches
2141/3141	177.8 x 177.8	7 x 7

#### Reduced rails drawer fronts (Height x Width)

Model	mm	inches
3141red	101.6 x 177.8	4 x 7

red = reduced rails

Default exterior profile: Y

Series 41 drawer fronts are manufactured with regular rails. If reduced rails drawer fronts are required, it must be specified when ordering.

## SERIES 42 Category 6



Model **2142**  
Color: A15WT

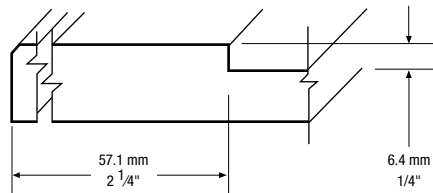

Model **3142**  
Regular rails

Model **3142**  
Reduced rails

### Minimum dimensions

#### Doors and drawer fronts (Height x Width)

Model	mm	inches
2142/3142	139.7 x 139.7	5 1/2 x 5 1/2

#### Reduced rails drawer fronts (Height x Width)

Model	mm	inches
3142red	101.6 x 139.7	4 x 5 1/2

red = reduced rails

Default exterior profile: Y

Series 42 drawer fronts are manufactured with regular rails. If reduced rails drawer fronts are required, it must be specified when ordering.



## STANDARD SPECIFICATIONS

- White melamine back
- The default woodgrain direction is vertical
- Shaker drawer fronts are manufactured with regular rails (unless reduced rails are specified)
- Maximum door height: 2438 mm (96"), maximum door width: 1193 mm (47")

## SERIES 51 Cat. 6 / 55 Cat. 6



**Model 2151**  
Color: A15WT

### 51 | Shaker style

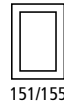
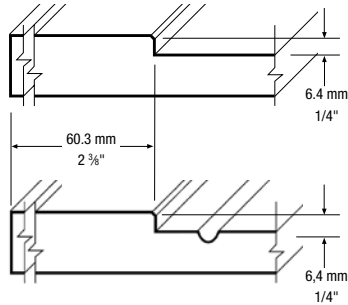

151/155



251/255



351/355



451/455

### 55 | Shaker style with grooves

The first groove starts at the center of the door



**Model 3151**  
Regular rails



**Model 3151**  
Reduced rails

### Minimum dimensions

#### Doors and drawer fronts (Height x Width)

Model	mm	inches
2151/2155/3151/3155	146.0 x 146.0	5 3/4 x 5 3/4
2251/2255/3251/3255	161.0 x 146.0	6 11/32 x 5 3/4
2351/2355/3351/3355	186.0 x 200.6	7 11/32 x 7 29/32
2451/2455/3451/3455	((W±2) + 99.5) x 146.0	((W±2) + 3 15/16) x 5 3/4

#### Reduced rails drawer fronts (Height x Width)

Model	mm	inches
3151/3155red	76.2 x 146.0	3 x 5 3/4
3251/3255red	91.2 x 146.0	3 19/32 x 5 3/4
3351/3355red	116.2 x 200.6	4 9/16 x 7 7/8
3451/3455red	((W±2) + 29.7) x 146.0	((W±2) + 1 5/32) x 5 3/4

red = reduced rails / W = width  
Default exterior profile: Y

Series 51 and 55 drawer fronts are manufactured with regular rails. If reduced rails drawer fronts are required, it must be specified when ordering.

**Model 2155**  
Color: A15WT



**55**  
Category 6

## SERIES 52 Cat. 6 / 56 Cat. 6



**Model 2152**  
Color: R82S

### 52 | Shaker style

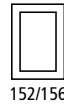
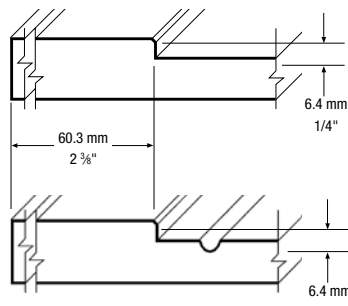

152/156



252/256



352/356



452/456

### 56 | Shaker style with grooves

The first groove starts at the center of the door



**Model 3152**  
Regular rails



**Model 3152**  
Reduced rails

### Minimum dimensions

#### Doors and drawer fronts (Height x Width)

Model	mm	inches
2152/2156/3152/3156	146.0 x 146.0	5 3/4 x 5 3/4
2252/2256/3252/3256	161.0 x 146.0	6 11/32 x 5 3/4
2352/2356/3352/3356	186.0 x 200.6	7 11/32 x 7 7/8
2452/2456/3452/3456	((W±2) + 99.5) x 146.0	((W±2) + 3 29/32) x 5 3/4

#### Reduced rails drawer fronts (Height x Width)

Model	mm	inches
3152/3156red	76.2 x 146.0	3 x 5 3/4
3252/3256red	91.2 x 146.0	3 19/32 x 5 3/4
3352/3356red	116.2 x 200.6	4 9/16 x 7 7/8
3452/3456red	((W±2) + 29.7) x 146.0	((W±2) + 1 5/32) x 5 3/4

red = reduced rails / W = width  
Default exterior profile: Y

Series 52 and 56 drawer fronts are manufactured with regular rails. If reduced rails drawer fronts are required, it must be specified when ordering.

**Model 2156**  
Color: R82S



**56**  
Category 6

# SHAKER MODELS

## OPTION:

- See availability of same color melamine back, pages 47-48.

## SERIES 61 Cat. 6 / 65 Cat. 6



Model **2161**  
Color: K85S

### 61 | Shaker style

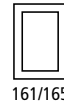
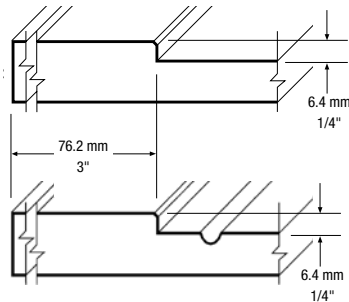

161/165



261/265

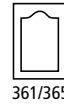

361/365



461/465

### 65 | Shaker style with grooves

The first groove starts at the center of the door



Model **3161**  
Regular rails



Model **3161**  
Reduced rails

## Minimum dimensions

### Doors and drawer fronts (Height x Width)

Model	mm	inches
2161/2165/3161/3165	177.8 x 177.8	7 x 7
2261/2265/3261/3265	192.8 x 177.8	7 19/32 x 7
2361/2365/3361/3365	217.8 x 232.4	8 19/32 x 9 5/32
2461/2465/3461/3465	$((W \div 2) + 115.4) \times 177.8$	$((W \div 2) + 4 9/16) \times 7$

### Reduced rails drawer fronts (Height x Width)

Model	mm	inches
3161/3165red	76.2 x 177.8	3 x 7
3261/3265red	91.2 x 177.8	3 19/32 x 7
3361/3365red	116.2 x 232.4	4 19/32 x 9 5/32
3461/3465red	$((W \div 2) + 13.8) \times 177.8$	$((W \div 2) + 9/16) \times 7$

red = reduced rails / W = width  
Default exterior profile: Y

Series 61 and 65 drawer fronts are manufactured with regular rails. If reduced rails drawer fronts are required, it must be specified when ordering.

Model **2165**  
Color: K85S



**65**  
Category 6

## SERIES 62 Cat. 6 / 66 Cat. 6



Model **2162**  
Color: V66WT

### 62 | Shaker style

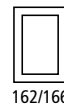
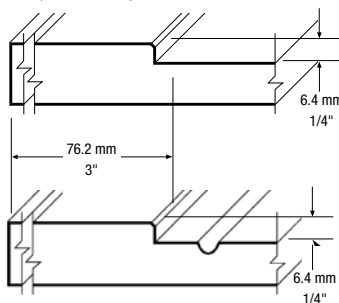

162/166

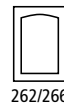

262/266

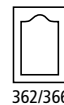

362/366

### 66 | Shaker style with grooves

The first groove starts at the center of the door



Model **3162**  
Regular rails



Model **3162**  
Reduced rails

## Minimum dimensions

### Doors and drawer fronts (Height x Width)

Model	mm	inches
2162/2166/3162/3166	177.8 x 177.8	7 x 7
2262/2266/3262/3266	192.8 x 177.8	7 19/32 x 7
2362/2366/3362/3366	217.8 x 232.4	8 19/32 x 9 5/32
2462/2466/3462/3466	$((W \div 2) + 115.4) \times 177.8$	$((W \div 2) + 4 9/16) \times 7$

### Reduced rails drawer fronts (Height x Width)

Model	mm	inches
3162/3166red	76.2 x 177.8	3 x 7
3262/3266red	91.2 x 177.8	3 19/32 x 7
3362/3366red	116.2 x 232.4	4 19/32 x 9 5/32
3462/3466red	$((W \div 2) + 13.8) \times 177.8$	$((W \div 2) + 9/16) \times 7$

red = reduced rails / W = width  
Default exterior profile: Y

Series 62 and 66 drawer fronts are manufactured with regular rails. If reduced rails drawer fronts are required, it must be specified when ordering.

Model **2166**  
Color: V66WT



**66**  
Category 6



## STANDARD SPECIFICATIONS

- White melamine back
- The default woodgrain direction is vertical

- Shaker drawer fronts are manufactured with regular rails (unless reduced rails are specified)
- Maximum door height: 2438 mm (96"), maximum door width: 1193 mm (47")

## SERIES 70 Category 6



**Model 2170**  
Color: V66WT

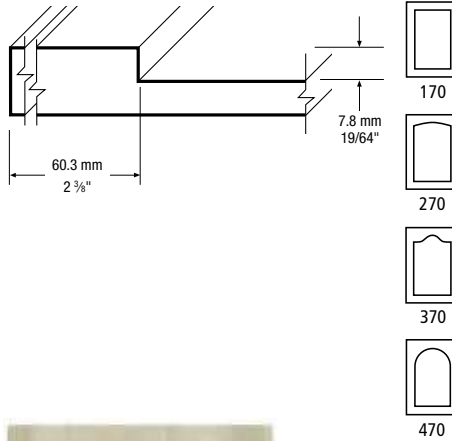

**Model 3170**  
Regular rails

**Model 3170**  
Reduced rails

### Minimum dimensions

#### Doors and drawer fronts (Height x Width)

Model	mm	inches
2170/3170	146.0 x 146.0	5 3/4 x 5 3/4
2270/3170	161.0 x 146.0	6 11/32 x 5 3/4
2370/3370	186.0 x 200.6	7 11/32 x 7 29/32
2470/3470	$((W \div 2) + 99.5) \times 146.0$	$((W \div 2) + 3 31/32) \times 5 3/4$

#### Reduced rails drawer fronts (Height x Width)

Model	mm	inches
3170red	76.2 x 146.0	3 x 5 3/4
3270red	91.2 x 146.0	3 19/32 x 5 3/4
3370red	116.2 x 200.6	4 9/16 x 7 7/8
3470red	$((W \div 2) + 29.7) \times 146.0$	$((W \div 2) + 1 11/64) \times 5 3/4$

red = reduced rails / W = width  
Default exterior profile: B

Series 70 drawer fronts are manufactured with regular rails. If reduced rails drawer fronts are required, it must be specified when ordering.

## SERIES 71 Category 6



**Model 2171**  
Color: K85S

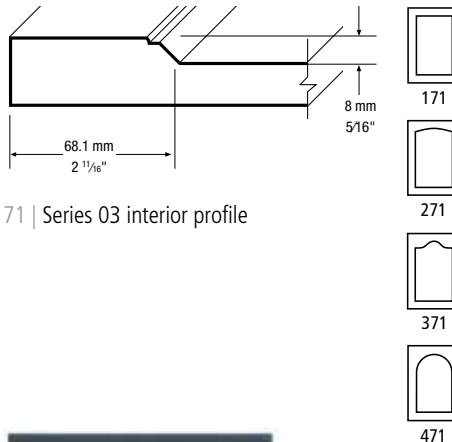

71 | Series 03 interior profile



**Model 3171**  
Regular rails

**Model 3171**  
Reduced rails

### Minimum dimensions

#### Doors and drawer fronts (Height x Width)

Model	mm	inches
2171/3171	161.6 x 161.6	6 3/8 x 6 3/8
2271/3271	176.6 x 161.6	6 31/32 x 6 3/8
2371/3371	201.6 x 201.8	7 15/16 x 7 31/32
2471/3471	$((W \div 2) + 82.5) \times 161.6$	$((W \div 2) + 3 1/4) \times 6 3/8$

#### Reduced rails drawer fronts (Height x Width)

Model	mm	inches
3171red	102.0 x 161.6	4 1/64 x 6 3/8
3271red	117.0 x 161.6	4 39/64 x 6 3/8
3371red	142.0 x 201.8	5 19/32 x 7 31/32
3471red	$((W \div 2) + 22.9) \times 161.6$	$((W \div 2) + 29/32) \times 6 3/8$

red = reduced rails / W = width  
Default exterior profile: B

Series 71 drawer fronts are manufactured with regular rails. If reduced rails drawer fronts are required, it must be specified when ordering.

# SHAKER MODELS

## OPTION:

- See availability of same color melamine back, pages 47-48.

## SERIES 72 Category 6



Model **2172**  
Color: A661S

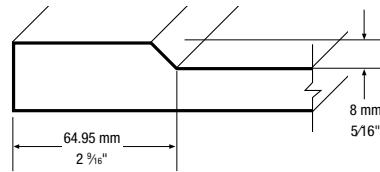

72 | Series 09 interior profile



Model **3172**  
Regular rails



Model **3172**  
Reduced rails

### Minimum dimensions

#### Doors and drawer fronts (Height x Width)

Model	mm	inches
2172/3172	155.3 x 155.3	6 1/8 x 6 1/8
2272/3272	170.3 x 155.3	6 23/32 x 6 1/8
2372/3372	195.3 x 193.9	7 23/32 x 7 21/32
2472/3472	$((W \div 2) + 79.8) \times 155.3$	$((W \div 2) + 3 1/8) \times 6 1/8$

#### Reduced rails drawer fronts (Height x Width)

Model	mm	inches
3172red	91.3 x 155.3	3 5/8 x 6 1/8
3272red	106.3 x 155.3	4 3/16 x 6 1/8
3372red	131.3 x 193.9	5 3/16 x 7 21/32
3472red	$((W \div 2) + 15.4) \times 155.3$	$((W \div 2) + 39/64) \times 6 1/8$

red = reduced rails / W = width  
Default exterior profile: B

Series 72 drawer front are manufactured with regular rails. If reduced rails drawer fronts are required, it must be specified when ordering.

## SERIES 77 Category 6



Model **2177**  
Color: A4WT

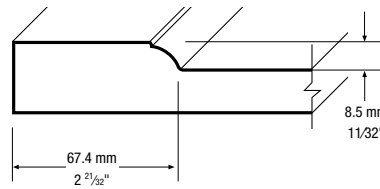

77 | Series 83 interior profile



Model **3177**  
Regular rails



Model **3177**  
Reduced rails

### Minimum dimensions

#### Doors and drawer fronts (Height x Width)

Model	mm	inches
2177/3177	179.8 x 179.8	7 3/32 x 7 3/32
2277/3277	194.8 x 179.8	7 11/16 x 7 3/32
2377/3377	219.8 x 214.8	8 21/32 x 8 15/32
2477/3477	$((W \div 2) + 112.5) \times 179.8$	$((W \div 2) + 4 7/16) \times 7 3/32$

#### Reduced rails drawer fronts (Height x Width)

Model	mm	inches
3177red	116.6 x 179.8	4 19/32 x 7 3/32
3277red	131.6 x 179.8	5 3/16 x 7 3/32
3377red	156.6 x 214.8	6 3/16 x 8 15/32
3477red	$((W \div 2) + 49.3) \times 179.8$	$((W \div 2) + 1 31/32) \times 7 3/32$

red = reduced rails / W = width  
Default exterior profile: C

Series 77 drawer front are manufactured with regular rails. If reduced rails drawer fronts are required, it must be specified when ordering.

## STANDARD SPECIFICATIONS

- White melamine back
- The default woodgrain direction is vertical
- Shaker drawer fronts are manufactured with regular rails (unless reduced rails are specified)
- Maximum door height: 2438 mm (96"), maximum door width: 1193 mm (47")

## SERIES 78 Category 6



Model **2178**  
Color: A4WT

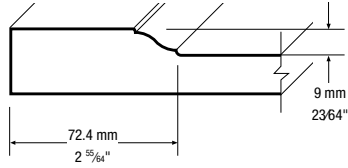

78 | Series 85 interior profile



Model **3178**  
Regular rails

Model **3178**  
Reduced rails



### Minimum dimensions

#### Doors and drawer fronts (Height x Width)

Model	mm	inches
2178/3178	189.8 x 189.8	7 1/2 x 7 1/2
2278/3278	204.8 x 189.8	8 3/32 x 7 1/2
2378/3378	229.8 x 224.8	9 1/16 x 8 7/8
2478/3478	$(W \div 2) + 117.5$ x 189.8	$(W \div 2) + 4 21/32$ x 7 1/2

#### Reduced rails drawer fronts (Height x Width)

Model	mm	inches
3178red	126.6 x 189.8	5 x 7 1/2
3278red	141.6 x 189.8	5 19/32 x 7 1/2
3378red	166.6 x 224.8	6 9/16 x 8 7/8
3478red	$(W \div 2) + 54.3$ x 189.8	$(W \div 2) + 2 5/32$ x 7 1/2

red = reduced rails / W = width  
Default exterior profile: C

Series 78 drawer fronts are manufactured with regular rails. If reduced rails drawer fronts are required, it must be specified when ordering.

## SERIES 79 Category 6



Model **2179**  
Color: A661S

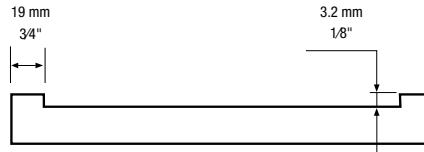

Model **3179**  
Regular rails

### Minimum dimensions

#### Doors and drawer fronts (Height x Width)

Model	mm	inches
2179/3179	76.2 x 76.2	3 x 3

W = width  
Default exterior profile: Y

Series 79 drawer fronts are manufactured with regular rails. Frame and mullion doors not available in this model. Available exterior profiles: I, J, Q, Y and 6.

# SHAKER MODELS

## OPTION:

- See availability of same color melamine back, pages 47-48.

## SERIES 80 Category 6



Model **2180**  
Color: K464WT

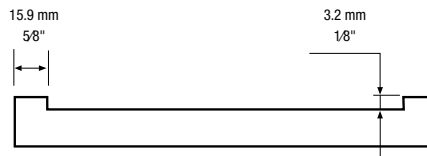

Model **3180**  
Regular rails

### Minimum dimensions

Doors and drawer fronts (Height x Width)

Model	mm	inches
2180/3180	76.2 x 76.2	3 x 3

W = width

Default exterior profile: Y

Series 80 drawer fronts are manufactured with regular rails. Frame and mullion doors not available in this model. Available exterior profiles: I, J, Q, Y and 6.

## SERIES 942 Category 6



Model **2942**  
Color: K257S

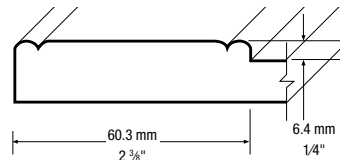

Model **3942**  
Regular rails



Model **3942**  
Reduced rails

### Minimum dimensions

Doors and drawer fronts (Height x Width)

Model	mm	inches
2942/3942	146.0 x 146.0	5 3/4 x 5 3/4

Reduced rails drawer fronts (Height x Width)

Model	mm	inches
3942red	76.2 x 146.0	3 x 5 3/4

red = reduced rails

Default exterior profile: W

Series 942 drawer fronts are manufactured with regular rails. If reduced rails drawer fronts are required, it must be specified when ordering.

## STANDARD SPECIFICATIONS

- White melamine back
- The default woodgrain direction is vertical
- Shaker drawer fronts are manufactured with regular rails (unless reduced rails are specified)
- Maximum door height: 2438 mm (96"), maximum door width: 1193 mm (47")

### SERIES 64 Category 4



Model **2164**  
Color: K257S

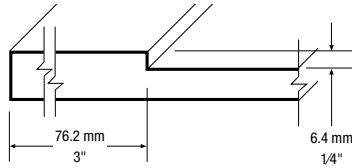

Model **3164**  
Regular rails



Model **3164**  
Reduced rails

#### Minimum dimensions

##### Doors and drawer fronts (Height x Width)

Model	mm	inches
2164/3164	177.8 x 177.8	7 x 7

##### Reduced rails drawer fronts (Height x Width)

Model	mm	inches
3164red	76.2 x 177.8	3 x 7

red = reduced rails

Default exterior profile: Y

Series 64 drawer fronts are manufactured with regular rails. If reduced rails drawer fronts are required, it must be specified when ordering.

### SERIES 67 Category 4



Model **2167**  
Color: K464WT

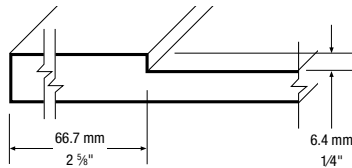

Model **3167**  
Regular rails



Model **3167**  
Reduced rails

#### Minimum dimensions

##### Doors and drawer fronts (Height x Width)

Model	mm	inches
2167/3167	158.8 x 158.8	6 1/4 x 6 1/4

##### Reduced rails drawer fronts (Height x Width)

Model	mm	inches
3167red	76.2 x 158.8	3 x 6 1/4

red = reduced rails

Default exterior profile: Y

Series 67 drawer fronts are manufactured with regular rails. If reduced rails drawer fronts are required, it must be specified when ordering.

# SHAKER MODELS

## OPTION:

- See availability of same color melamine back, pages 47-48.

## SERIES 764 Category 5



Model **2764**  
Color: R82S

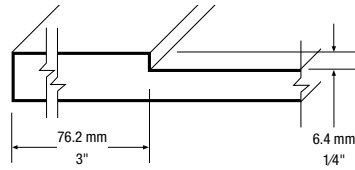

Model **3764**  
Regular rails



Model **3764**  
Reduced rails

### Minimum dimensions

#### Doors and drawer fronts (Height x Width)

Model	mm	inches
2764/3764	177.8 x 177.8	7 x 7

#### Reduced rails drawer fronts (Height x Width)

Model	mm	inches
3764red	76.2 x 177.8	3 x 7

red = reduced rails

Default exterior profile: Y

Series 764 drawer fronts are manufactured with regular rails. If reduced rails drawer fronts are required, it must be specify when ordering.

## SERIES 767 Category 5



Model **2767**  
Color: A15WT

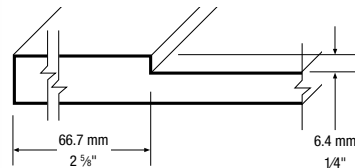

Model **3767**  
Regular rails



Model **3767**  
Reduced rails

### Minimum dimensions

#### Doors and drawer fronts (Height x Width)

Model	mm	inches
2767/3767	158.8 x 158.8	6 1/4 x 6 1/4

#### Reduced rails drawer fronts (Height x Width)

Model	mm	inches
3767red	76.2 x 158.8	3 x 6 1/4

red = reduced rails

Default exterior profile: Y

Series 767 drawer fronts are manufactured with regular rails. If reduced rails drawer fronts are required, it must be specify when ordering.



## STANDARD SPECIFICATIONS

- White melamine back
- The default woodgrain direction is vertical
- Shaker drawer fronts are manufactured with regular rails (unless reduced rails are specified)
- Maximum door height: 2438 mm (96"), maximum door width: 1193 mm (47")

## SERIES 945 Category 7



Model **2945**  
Color : A15WT

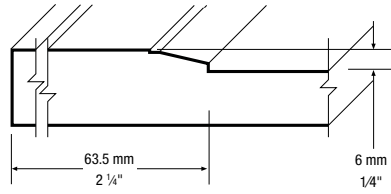

Model **3945**  
Regular rails



Model **3945**  
Reduced rails

### Minimum dimensions

#### Doors and drawer fronts (Height x Width)

Model	mm	inches
2945/3945	152.4 x 152.4	6 x 6

#### Reduced rails drawer fronts (Height x Width)

Model	mm	inches
2945red	101.6 x 152.4	4 x 6

red = reduced rails  
Default exterior profile: Y

Series 945 drawer fronts are manufactured with regular rails. If reduced rails drawer fronts are required, it must be specify when ordering.



C35S - White - Satin

# SLAB MODELS

## OPTION:

- See availability of same color melamine back, pages 47-48.

## SERIES 00 Category 1



Model **2000**  
Color: K85S

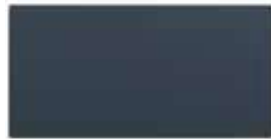
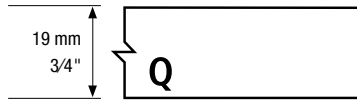

Model **3000**

Minimum dimensions for series 00 vary according to the exterior profile selected:

Doors and drawer fronts (Height x Width)

Model	Exterior profile	mm	inches
2000/3000	A, B, C, G, I, J, K, L, M, O, Q, R, S, T, U, V, Y, 6	38.1 x 38.1	1 1/2 x 1 1/2
2000/3000	D, E, W	50.8 x 50.8	2 x 2
2000/3000	F	76.2 x 76.2	3 x 3
2000/3000	H	82.6 x 82.6	3 1/4 x 3 1/4
2000/3000	P	90.5 x 90.5	3 9/16 x 3 9/16

Minimum charge of 0.19 sq.m. (2 sq.ft.) for thermoplastic fillers whose height or width is less than 76.2 mm (3") and whose length is greater than 1828 mm (72").

Frame and mullion doors not available in this model.

## SERIES 00 Category 1



Model **2000**  
Color: V66WT

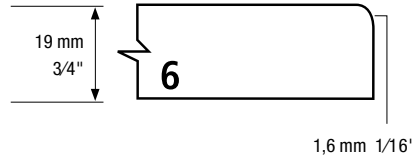

Model **3000**

Minimum dimensions for series 00 vary according to the exterior profile selected:

Doors and drawer fronts (Height x Width)

Model	Exterior profile	mm	inches
2000/3000	A, B, C, G, I, J, K, L, M, O, Q, R, S, T, U, V, Y, 6	38.1 x 38.1	1 1/2 x 1 1/2
2000/3000	D, E, W	50.8 x 50.8	2 x 2
2000/3000	F	76.2 x 76.2	3 x 3
2000/3000	H	82.6 x 82.6	3 1/4 x 3 1/4
2000/3000	P	90.5 x 90.5	3 9/16 x 3 9/16

Minimum charge of 0.19 sq.m. (2 sq.ft.) for thermoplastic fillers whose height or width is less than 76.2 mm (3") and whose length is greater than 1828 mm (72").

Frame and mullion doors not available in this model.

## STANDARD FEATURES

- White melamine back
- The default woodgrain direction is vertical

- Maximum door height: 2438 mm (96")
- Maximum door width: 1193 mm (47")

## SERIES 00 Category 1



Model **2000**  
Color: V66WT

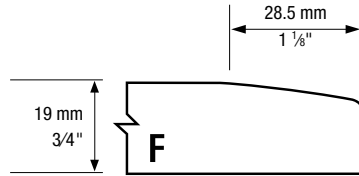

Model **3000**

Minimum dimensions for series 00 vary according to the exterior profile selected:

Doors and drawer fronts (Height x Width)

Model	Exterior profile	mm	inches
2000/3000	A, B, C, G, I, J, K, L, M, O, Q, R, S, T, U, V, Y, 6	38.1 x 38.1	1 1/2 x 1 1/2
2000/3000	D, E, W	50.8 x 50.8	2 x 2
2000/3000	F	76.2 x 76.2	3 x 3
2000/3000	H	82.6 x 82.6	3 1/4 x 3 1/4
2000/3000	P	90.5 x 90.5	3 9/16 x 3 9/16

Minimum charge of 0.19 sq.m. (2 sq.ft.) for thermoplastic fillers whose height or width is less than 76.2 mm (3") and whose length is greater than 1828 mm (72").

Frame and mullion doors not available in this model.

## SERIES 00 Category 2



Model **2000**  
Color: K85S

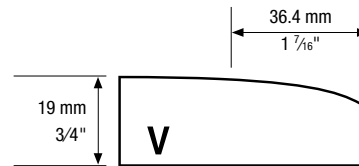

Model **3000**

Minimum dimensions for series 00 vary according to the exterior profile selected:

Doors and drawer fronts (Height x Width)

Model	Exterior profile	mm	inches
2000/3000	A, B, C, G, I, J, K, L, M, O, Q, R, S, T, U, V, Y, 6	38.1 x 38.1	1 1/2 x 1 1/2
2000/3000	D, E, W	50.8 x 50.8	2 x 2
2000/3000	F	76.2 x 76.2	3 x 3
2000/3000	H	82.6 x 82.6	3 1/4 x 3 1/4
2000/3000	P	90.5 x 90.5	3 9/16 x 3 9/16

Minimum charge of 0.19 sq.m. (2 sq.ft.) for thermoplastic fillers whose height or width is less than 76.2 mm (3") and whose length is greater than 1828 mm (72").

Frame and mullion doors not available in this model.

# STANDARD MODELS

## OPTIONS:

- See availability of same color melamine back, pages 47-48.
- For regular rails drawer fronts, order as a door.

## SERIES 03 Category 4



**Model 2103**  
Color: A661S

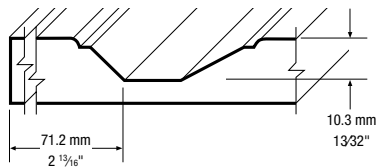

**Model 3103**  
Standard models

### Minimum dimensions

#### Doors (Height x Width)

Model	mm	inches
2103	225.0 x 225.0	8 7/8 x 8 7/8
2203	240.0 x 225.0	9 15/32 x 8 7/8
2303	265.0 x 225.0	10 7/16 x 8 7/8
2403	$((W \div 2) + 82.5) \times 225.0$	$((W \div 2) + 3 1/4) \times 8 7/8$

#### Drawer fronts (Height x Width)

Model	mm	inches
3103	146.4 x 225.0	5 25/32 x 8 7/8
3203	161.4 x 225.0	6 3/8 x 8 7/8
3303	186.4 x 225.0	7 11/32 x 8 7/8
3403	$((W \div 2) + 3.9) \times 225.0$	$((W \div 2) + 5/32) \times 8 7/8$

W = width  
Default exterior profile: B

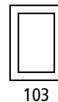

103



203



303



403

## SERIES 27 Category 4



**Model 2127**  
Color: A4WT

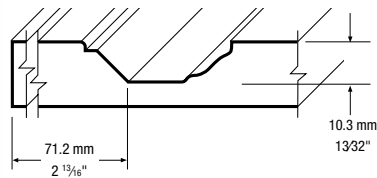

**Model 3127**  
Reduced rails

### Minimum dimensions

#### Doors (Height x Width)

Model	mm	inches
2127	208.4 x 208.4	8 7/32 x 8 7/32
2227	223.4 x 208.4	8 13/16 x 8 7/32
2327	248.4 x 208.4	9 25/32 x 8 7/32
2427	$((W \div 2) + 81.2) \times 208.4$	$((W \div 2) + 3 7/32) \times 8 7/32$

#### Drawer fronts (Height x Width)

Model	mm	inches
3127	129.8 x 208.4	5 1/8 x 8 7/32
3227	144.8 x 208.4	5 23/32 x 8 7/32
3327	169.8 x 208.4	6 11/16 x 8 7/32
3427	$((W \div 2) + 2.6) \times 208.4$	$((W \div 2) + 1/8) \times 8 7/32$

W = width  
Default exterior profile: A



127



227



327



427

## STANDARD SPECIFICATIONS

- White melamine back
- The default woodgrain direction is vertical

- Drawer fronts are manufactured with reduced rails (unless regular rails are specified)
- Maximum door height: 2438 mm (96"), maximum door width: 1193 mm (47")

## SERIES 49 Category 4



Model **2149**  
Color: A4WT

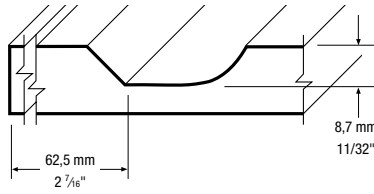

149



249



349



449

### Minimum dimensions

#### Doors (Height x Width)

Model	mm	inches
2149	195.6 x 195.6	7 <sup>23</sup> / <sub>32</sub> x 7 <sup>23</sup> / <sub>32</sub>
2249	210.6 x 195.6	8 <sup>5</sup> / <sub>16</sub> x 7 <sup>23</sup> / <sub>32</sub>
2349	238.6 x 220.0	9 <sup>13</sup> / <sub>32</sub> x 8 <sup>11</sup> / <sub>16</sub>
2449	((W÷2) + 77) x 195.6	((W÷2) + 3 <sup>1</sup> / <sub>16</sub> ) x 7 <sup>23</sup> / <sub>32</sub>

#### Drawer fronts (Height x Width)

Model	mm	inches
3149	139.6 x 195.6	5 <sup>1</sup> / <sub>2</sub> x 7 <sup>23</sup> / <sub>32</sub>
3249	154.6 x 195.6	6 <sup>3</sup> / <sub>32</sub> x 7 <sup>23</sup> / <sub>32</sub>
3349	185.6 x 220.0	7 <sup>5</sup> / <sub>16</sub> x 8 <sup>11</sup> / <sub>16</sub>
3449	((W÷2) + 21) x 195.6	((W÷2) + <sup>27</sup> / <sub>32</sub> ) x 7 <sup>23</sup> / <sub>32</sub>

W = width  
Default exterior profile: C



Model **3149**  
Reduced rails

## SERIES 50 Cat. 2 / 40 Cat. 2



Model **2150**  
Color: A661S

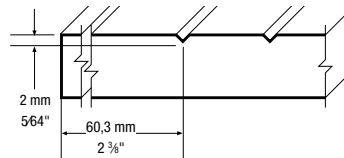

50 | Standard style with grooves

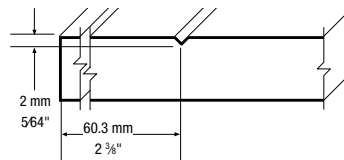

40 | Standard style



150



250



350



450



Model **3150**  
Regular rails



Model **3150**  
Reduced rails

### Minimum dimensions

#### Doors and drawer fronts (Height x Width)

Model	mm	inches
2150/2140/3150/3140	146.0 x 146.0	5 <sup>3</sup> / <sub>4</sub> x 5 <sup>3</sup> / <sub>4</sub>
2250/2240/3250/3240	161.0 x 146.0	6 <sup>11</sup> / <sub>32</sub> x 5 <sup>3</sup> / <sub>4</sub>
2350/2340/3350/3340	186.0 x 200.6	7 <sup>11</sup> / <sub>32</sub> x 7 <sup>29</sup> / <sub>32</sub>
2450/2440/3450/3440	((W÷2) + 60.4) x 146.0	((W÷2) + 2 <sup>13</sup> / <sub>32</sub> ) x 5 <sup>3</sup> / <sub>4</sub>

#### Reduced rails drawer fronts (Height x Width)

Model	mm	inches
3150/3140red	76.2 x 146.0	3 x 5 <sup>3</sup> / <sub>4</sub>
3250/3240red	91.2 x 146.0	3 <sup>19</sup> / <sub>32</sub> x 5 <sup>3</sup> / <sub>4</sub>
3350/3340red	116.2 x 200.6	4 <sup>19</sup> / <sub>32</sub> x 7 <sup>29</sup> / <sub>32</sub>
3450/3440red	((W÷2) - 9.4) x 146.0	((W÷2) - <sup>3</sup> / <sub>8</sub> ) x 5 <sup>3</sup> / <sub>4</sub>

Note: Not available with exterior profiles D, F, H, P, V and W.  
red = reduced rails / W = width

Default exterior profile: Q

Series 40 and 50 drawer fronts are manufactured with regular rails.  
If reduced rails drawer fronts are required, it must be specify when ordering.

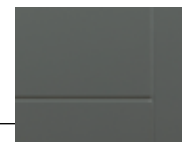

Model **2140**  
Color: A661S

40

Category 2

# STANDARD MODELS

## OPTIONS:

- See availability of same color melamine back, pages 47-48.
- For regular rails drawer fronts, order as a door.

## SERIES 73 Category 3



Model **2173**  
Color: K464WT

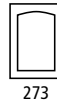
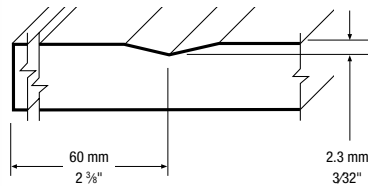

Model **3173**  
Reduced rails

### Minimum dimensions

#### Doors (Height x Width)

Model	mm	inches
2173	153.7 x 153.7	6 1/16 x 6 1/16
2273	168.7 x 153.7	6 21/32 x 6 1/16
2373	193.7 x 200.0	7 21/32 x 7 7/8
2473	$((W \div 2) + 60.1) \times 153.7$	$((W \div 2) + 2 \frac{3}{8}) \times 6 \frac{1}{16}$

#### Drawer fronts (Height x Width)

Model	mm	inches
3173	93.7 x 153.7	3 23/32 x 6 1/16
3273	108.7 x 153.7	4 9/32 x 6 1/16
3373	133.7 x 200.0	5 9/32 x 7 7/8
3473	$((W \div 2) + 0.1) \times 153.7$	$((W \div 2) + 1/32) \times 6 \frac{1}{16}$

W = width  
Default exterior profile: B

## SERIES 76 Category 4



Model **2176**  
Color: K257S

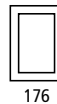
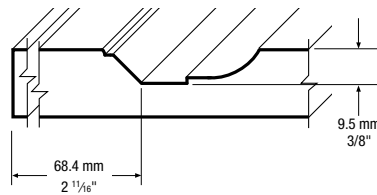

Model **3176**  
Reduced rails

### Minimum dimensions

#### Doors (Height x Width)

Model	mm	inches
2176	216.1 x 216.1	8 17/32 x 8 17/32
2276	231.1 x 216.1	9 1/8 x 8 17/32
2376	256.1 x 216.1	10 3/32 x 8 17/32
2476	$((W \div 2) + 87.7) \times 216.1$	$((W \div 2) + 3 \frac{15}{32}) \times 8 \frac{17}{32}$

#### Drawer fronts (Height x Width)

Model	mm	inches
3176	149.2 x 216.1	5 7/8 x 8 17/32
3276	164.2 x 216.1	6 15/32 x 8 17/32
3376	189.2 x 216.1	7 15/32 x 8 17/32
3476	$((W \div 2) + 20.9) \times 216.1$	$((W \div 2) + 27/32) \times 8 \frac{17}{32}$

W = width  
Default exterior profile: B



## STANDARD SPECIFICATIONS

- White melamine back
- The default woodgrain direction is vertical

- Drawer fronts are manufactured with reduced rails (unless regular rails are specified)
- Maximum door height: 2438 mm (96"), maximum door width: 1193 mm (47")

## SERIES 83 Cat. 6 / 93 Cat. 5



Model **2183**  
Color: K257S

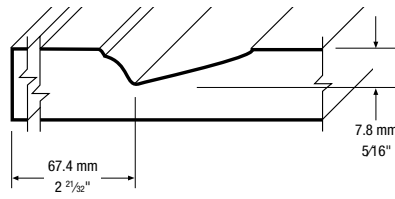

- 83 | Square and beveled corners
- 93 | Square interior profile as series 83, without beveled corners



183

193



283

293



383

393



483

493



Model **3183**  
Reduced rails



Model **2193**  
Color: K257S

93

Category 5

### Minimum dimensions

#### Doors (Height x Width)

Model	mm	inches
2183/2193	201.5 x 201.5	7 15/16 x 7 15/16
2283/2293	216.5 x 201.5	8 17/32 x 7 15/16
2383/2393	241.5 x 230.8	9 17/32 x 9 3/32
2483/2493	$((W \div 2) + 112.5) \times 201.5$	$((W \div 2) + 4 7/16) \times 7 15/16$

#### Drawer fronts (Height x Width)

Model	mm	inches
3183/3193	138.3 x 201.5	5 15/32 x 7 15/16
3283/3293	153.3 x 201.5	6 1/16 x 7 15/16
3383/3393	178.3 x 230.8	7 1/32 x 9 3/32
3483/3493	$((W \div 2) + 49.3) \times 201.5$	$((W \div 2) + 1 31/32) \times 7 15/16$

W = width

Default exterior profile: C

## SERIES 85 Cat. 6 / 95 Cat. 5



Model **2185**  
Color: K464WT

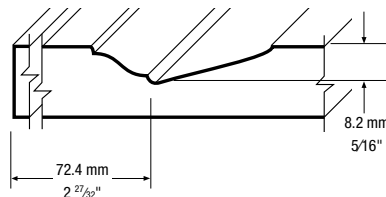

- 85 | Square and beveled corners
- 95 | Square interior profile as series 85, without beveled corners



185

195



285

295



385

395



485

495



Model **3185**  
Reduced rails



Model **2195**  
Color: K464WT

95

Category 5

### Minimum dimensions

#### Doors (Height x Width)

Model	mm	inches
2185/2195	212.4 x 212.4	8 3/8 x 8 3/8
2285/2295	227.4 x 212.4	8 31/32 x 8 3/8
2385/2395	252.4 x 250.8	9 15/16 x 9 7/8
2485/2495	$((W \div 2) + 117.5) \times 212.4$	$((W \div 2) + 4 21/32) \times 8 3/8$

#### Drawer fronts (Height x Width)

Model	mm	inches
3185/3195	149.2 x 212.4	5 7/8 x 8 3/8
3285/3295	164.2 x 212.4	6 15/32 x 8 3/8
3385/3395	189.2 x 250.8	7 15/32 x 9 7/8
3485/3495	$((W \div 2) + 54.3) \times 212.4$	$((W \div 2) + 2 5/32) \times 8 3/8$

W = width

Default exterior profile: C

# STANDARD MODELS

## OPTIONS:

- See availability of same color melamine back, pages 47-48.
- For regular rails drawer fronts, order as a door.

## SERIES 86 Cat. 6 / 96 Cat. 5



Model **2186**  
Color: R82S

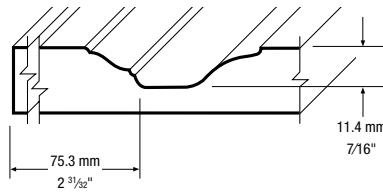

- 86 | Square and beveled corners
- 96 | Square interior profile as series 86, without beveled corners



186

196



286

296



386

396



486

496



Model **3186**  
Reduced rails



Model **2196**  
Color: R82S

96

Category 5

### Minimum dimensions

#### Doors (Height x Width)

Model	mm	inches
2186/2196	237.4 x 237.4	9 3/8 x 9 3/8
2286/2296	252.4 x 237.4	9 15/16 x 9 3/8
2386/2396	277.4 x 250.8	10 15/16 x 9 7/8
2486/2496	$((W \div 2) + 117.5) \times 237.4$	$((W \div 2) + 4 21/32) \times 9 3/8$

#### Drawer fronts (Height x Width)

Model	mm	inches
3186/3196	174.2 x 237.4	6 7/8 x 9 3/8
3286/3296	189.2 x 237.4	7 15/32 x 9 3/8
3386/3396	214.2 x 250.8	8 7/16 x 9 7/8
3486/3496	$((W \div 2) + 54.3) \times 237.4$	$((W \div 2) + 2 5/32) \times 9 3/8$

W = width  
Default exterior profile: C

## SERIES 87 Cat. 6 / 97 Cat. 5



Model **2187**  
Color: A15WT

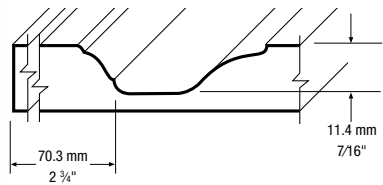

- 87 | Square and beveled corners
- 97 | Square interior profile as series 87, without beveled corners



187

197



287

297



387

397



487

497



Model **3187**  
Reduced rails



Model **2197**  
Color: A15WT

97

Category 5

### Minimum dimensions

#### Doors (Height x Width)

Model	mm	inches
2187/2197	227.4 x 227.4	8 31/32 x 8 31/32
2287/2297	242.4 x 227.4	9 9/16 x 8 31/32
2387/2397	267.4 x 230.8	10 17/32 x 9 3/32
2487/2497	$((W \div 2) + 112.5) \times 227.4$	$((W \div 2) + 4 7/16) \times 8 31/32$

#### Drawer fronts (Height x Width)

Model	mm	inches
3187/3197	164.2 x 227.4	6 15/32 x 8 31/32
3287/3297	179.2 x 227.4	7 1/16 x 8 31/32
3387/3397	204.2 x 230.8	8 1/16 x 9 3/32
3487/3497	$((W \div 2) + 49.3) \times 227.4$	$((W \div 2) + 1 31/32) \times 8 31/32$

W = width  
Default exterior profile: C

## STANDARD SPECIFICATIONS

- White melamine back
- The default woodgrain direction is vertical
- Drawer fronts are manufactured with reduced rails (unless regular rails are specified)
- Maximum door height: 2438 mm (96"), maximum door width: 1193 mm (47")

### SERIES 88 Cat. 6 / 98 Cat. 5



Model **2188**  
Color: A15WT

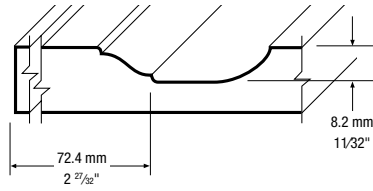

- 88 | Square and beveled corners
- 98 | Square interior profile as series 88, without beveled corners



188



198



288



298



388



398



488



498



Model **3188**  
Reduced rails



Model **2198**  
Color: A15WT

98

Category 5

#### Minimum dimensions

##### Doors (Height x Width)

Model	mm	inches
2188/2198	214.9 x 214.9	8 15/32 x 8 15/32
2288/2298	229.9 x 214.9	9 1/16 x 8 15/32
2388/2398	254.9 x 250.8	10 1/16 x 9 7/8
2488/2498	$((W \div 2) + 117.5) \times 214.9$	$((W \div 2) + 4 21/32) \times 8 15/32$

##### Drawer fronts (Height x Width)

Model	mm	inches
3188/3198	151.7 x 214.9	6 x 8 15/32
3288/3298	166.7 x 214.9	6 9/16 x 8 15/32
3388/3398	191.7 x 250.8	7 9/16 x 9 7/8
3488/3498	$((W \div 2) + 54.3) \times 214.9$	$((W \div 2) + 2 5/32) \times 8 15/32$

W = width

Default exterior profile: C

### SERIES 89 Cat. 6 / 99 Cat. 5



Model **2189**  
Color: R82S

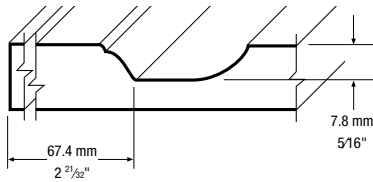

- 89 | Square and beveled corners
- 99 | Square interior profile as series 89, without beveled corners



189



199



289



299



389



399



489



499

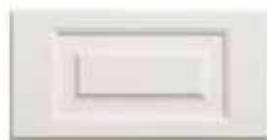

Model **3189**  
Reduced rails



Model **2199**  
Color: R82S

99

Category 5

#### Minimum dimensions

##### Doors (Height x Width)

Model	mm	inches
2189/2199	204.4 x 204.4	8 1/16 x 8 1/16
2289/2299	219.4 x 204.4	8 21/32 x 8 1/16
2389/2399	244.4 x 230.8	9 5/8 x 9 3/16
2489/2499	$((W \div 2) + 112.5) \times 204.4$	$((W \div 2) + 4 7/16) \times 8 1/16$

##### Drawer fronts (Height x Width)

Model	mm	inches
3189/3199	141.2 x 204.4	5 9/16 x 8 1/16
3289/3299	156.2 x 204.4	6 5/32 x 8 1/16
3389/3399	181.2 x 230.8	7 5/32 x 9 3/16
3489/3499	$((W \div 2) + 49.3) \times 204.4$	$((W \div 2) + 1 31/32) \times 8 1/16$

W = width

Default exterior profile: C

# STANDARD MODELS

## OPTIONS:

- See availability of same color melamine back, pages 47-48.
- For regular rails drawer fronts, order as a door.

## SERIES 912 Category 3



Model **2912**  
Color: K85S

R = 3 mm

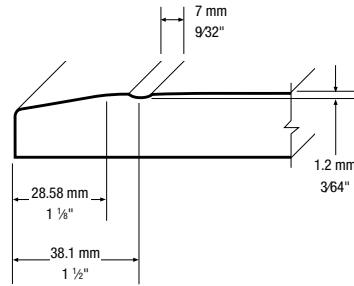

R = 3 mm

Model **3912**  
Regular rails

### Minimum dimensions

Doors (Height x Width)

Model	mm	inches
2912	95.9 x 95.9	3 25/32 x 3 25/32

Drawer fronts (Height x Width)

Model	mm	inches
3912	95.9 x 95.9	3 25/32 x 3 25/32

Default exterior profile: F

Model 912 drawer fronts are manufactured with regular rails.

## SERIES 01 Category 2



Model **2101**  
Color: V66WT

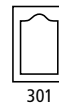
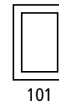
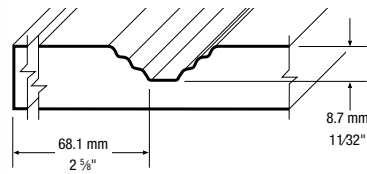

Model **3101**  
Reduced rails

### Minimum dimensions

Doors (Height x Width)

Model	mm	inches
2101	182.8 x 182.8	7 7/32 x 7 7/32
2201	201.3 x 182.8	7 15/16 x 7 7/32
2301	222.8 x 182.8	8 25/32 x 7 7/32
2401	$((W \div 2) + 71.6) \times 182.8$	$((W \div 2) + 2 27/32) \times 7 7/32$

Drawer fronts (Height x Width)

Model	mm	inches
3101	120.2 x 182.8	4 3/4 x 7 7/32
3201	138.7 x 182.8	5 15/32 x 7 7/32
3301	160.2 x 182.8	6 5/16 x 7 7/32
3401	$((W \div 2) + 9.0) \times 182.8$	$((W \div 2) + 3/8) \times 7 7/32$

W = width

Default exterior profile: C

## STANDARD SPECIFICATIONS

- White melamine back
- The default woodgrain direction is vertical

- Drawer fronts are manufactured with reduced rails (unless regular rails are specified)
- Maximum door height: 2438 mm (96"), maximum door width: 1193 mm (47")

## SERIES 04 Category 2



Model **2104**  
Color: V66WT

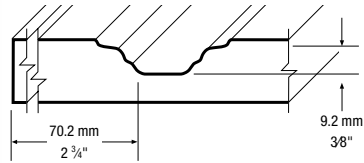

Model **3104**  
Reduced rails

### Minimum dimensions

#### Doors (Height x Width)

Model	mm	inches
2104	199.0 x 199.0	7 27/32 x 7 27/32
2204	214.0 x 199.0	8 7/16 x 7 27/32
2304	239.0 x 199.0	9 7/16 x 7 27/32
2404	$((W \div 2) + 75.1) \times 199.0$	$((W \div 2) + 2 31/32) \times 7 27/32$

#### Drawer fronts (Height x Width)

Model	mm	inches
3104	136.4 x 199.0	5 3/8 x 7 27/32
3204	151.4 x 199.0	5 31/32 x 7 27/32
3304	179.4 x 199.0	7 3/32 x 7 27/32
3404	$((W \div 2) + 12.5) \times 199.0$	$((W \div 2) + 1/2) \times 7 27/32$

W = width  
Default exterior profile: C

## SERIES 06 Category 3



Model **2106**  
Color: K85S

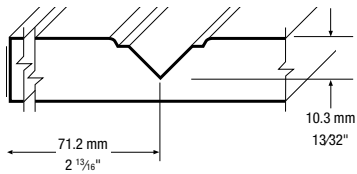

Model **3106**  
Reduced rails

### Minimum dimensions

#### Doors (Height x Width)

Model	mm	inches
2106	180.2 x 180.2	7 1/8 x 7 1/8
2206	195.2 x 180.2	7 11/16 x 7 1/8
2306	220.2 x 180.2	8 11/16 x 7 1/8
2406	$((W \div 2) + 81.5) \times 180.2$	$((W \div 2) + 3 7/32) \times 7 1/8$

#### Drawer fronts (Height x Width)

Model	mm	inches
3106	101.6 x 180.2	4 x 7 3/32
3206	116.6 x 180.2	4 19/32 x 7 3/32
3306	141.6 x 180.2	5 19/32 x 7 3/32
3406	$((W \div 2) + 2.9) \times 180.2$	$((W \div 2) + 1/8) \times 7 3/32$

W = width  
Default exterior profile: B

# STANDARD MODELS

## OPTIONS:

- See availability of same color melamine back, pages 47-48.
- For regular rails drawer fronts, order as a door.

## SERIES 07 Category 5



Model **2107**  
Color: A661S

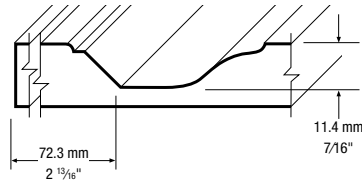

107



207



307



407



Model **3107**  
Reduced rails

### Minimum dimensions

#### Doors (Height x Width)

Model	mm	inches
2107	235.0 x 235.0	9 9/32 x 9 9/32
2207	250.0 x 235.0	9 27/32 x 9 9/32
2307	275.0 x 235.0	10 27/32 x 9 9/32
2407	((W÷2) + 86.8) x 235.0	((W÷2) + 3 7/16) x 9 9/32

#### Drawer fronts (Height x Width)

Model	mm	inches
3107	156.4 x 235.0	6 3/16 x 9 9/32
3207	171.4 x 235.0	6 3/4 x 9 9/32
3307	196.4 x 235.0	7 3/4 x 9 9/32
3407	((W÷2) + 8.2) x 235.0	((W÷2) + 11/32) x 9 9/32

W = width  
Default exterior profile: B

## SERIES 08 Category 3



Model **2108**  
Color: A4WT

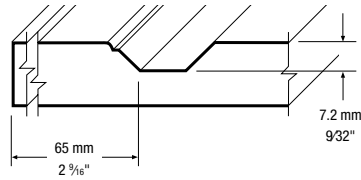

108



208



308



408



Model **3108**  
Reduced rails

### Minimum dimensions

#### Doors (Height x Width)

Model	mm	inches
2108	185.1 x 185.1	7 5/16 x 7 5/16
2208	200.1 x 185.1	7 29/32 x 7 5/16
2308	225.1 x 185.1	8 7/8 x 7 5/16
2408	((W÷2) + 71.8) x 185.1	((W÷2) + 2 27/32) x 7 5/16

#### Drawer fronts (Height x Width)

Model	mm	inches
3108	120.5 x 185.1	4 3/4 x 7 5/16
3208	135.5 x 185.1	5 11/32 x 7 5/16
3308	160.5 x 185.1	6 11/32 x 7 5/16
3408	((W÷2) + 7.8) x 185.1	((W÷2) + 5/16) x 7 5/16

W = width  
Default exterior profile: B



## STANDARD SPECIFICATIONS

- White melamine back
- The default woodgrain direction is vertical

- Drawer fronts are manufactured with reduced rails (unless regular rails are specified)
- Maximum door height: 2438 mm (96"), maximum door width: 1193 mm (47")

## SERIES 09 Category 3



Model **2109**  
Color: A4WT

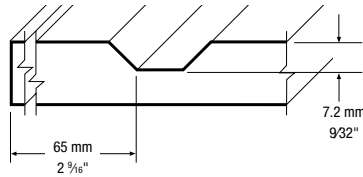

Model **3109**  
Reduced rails

### Minimum dimensions

#### Doors (Height x Width)

Model	mm	inches
2109	185.1 x 185.1	7 <sup>5</sup> / <sub>16</sub> x 7 <sup>5</sup> / <sub>16</sub>
2209	200.1 x 185.1	7 <sup>29</sup> / <sub>32</sub> x 7 <sup>5</sup> / <sub>16</sub>
2309	225.1 x 185.1	8 <sup>7</sup> / <sub>8</sub> x 7 <sup>5</sup> / <sub>16</sub>
2409	((W÷2) + 71.8) x 185.1	((W÷2) + 2 <sup>27</sup> / <sub>32</sub> ) x 7 <sup>5</sup> / <sub>16</sub>

#### Drawer fronts (Height x Width)

Model	mm	inches
3109	121.1 x 185.1	4 <sup>25</sup> / <sub>32</sub> x 7 <sup>5</sup> / <sub>16</sub>
3209	136.1 x 185.1	5 <sup>3</sup> / <sub>8</sub> x 7 <sup>5</sup> / <sub>16</sub>
3309	161.1 x 185.1	6 <sup>11</sup> / <sub>32</sub> x 7 <sup>5</sup> / <sub>16</sub>
3409	((W÷2) + 7.8) x 185.1	((W÷2) + <sup>5</sup> / <sub>16</sub> ) x 7 <sup>5</sup> / <sub>16</sub>

W = width  
Default exterior profile: B

## SERIES 15 Category 2



Model **2115**  
Color: A661S

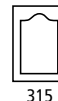
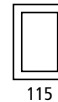
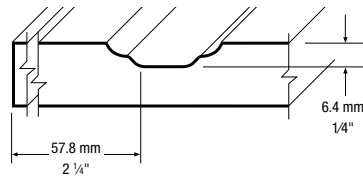

Model **3115**  
Reduced rails

### Minimum dimensions

#### Doors (Height x Width)

Model	mm	inches
2115	170.5 x 170.5	6 <sup>23</sup> / <sub>32</sub> x 6 <sup>23</sup> / <sub>32</sub>
2215	185.8 x 170.5	7 <sup>11</sup> / <sub>32</sub> x 6 <sup>23</sup> / <sub>32</sub>
2315	210.5 x 170.5	8 <sup>5</sup> / <sub>16</sub> x 6 <sup>23</sup> / <sub>32</sub>
2415	((W÷2) + 63.1) x 170.5	((W÷2) + 2 <sup>1</sup> / <sub>2</sub> ) x 6 <sup>23</sup> / <sub>32</sub>

#### Drawer fronts (Height x Width)

Model	mm	inches
3115	127.1 x 170.5	5 <sup>1</sup> / <sub>32</sub> x 6 <sup>23</sup> / <sub>32</sub>
3215	142.1 x 170.5	5 <sup>5</sup> / <sub>8</sub> x 6 <sup>23</sup> / <sub>32</sub>
3315	167.1 x 170.5	6 <sup>19</sup> / <sub>32</sub> x 6 <sup>23</sup> / <sub>32</sub>
3415	((W÷2) + 19.7) x 170.5	((W÷2) + <sup>25</sup> / <sub>32</sub> ) x 6 <sup>23</sup> / <sub>32</sub>

W = width  
Default exterior profile: U

# STANDARD MODELS

## OPTIONS:

- See availability of same color melamine back, pages 47-48.
- For regular rails drawer fronts, order as a door.

## SERIES 31 Category 3



**Model 2131**  
Color: K464WT

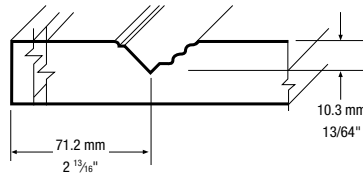

**Model 3131**  
Reduced rails

### Minimum dimensions

#### Doors (Height x Width)

Model	mm	inches
2131	199.4 x 199.4	7 27/32 x 7 27/32

#### Drawer fronts (Height x Width)

Model	mm	inches
3131	120.8 x 199.4	4 3/4 x 7 27/32

Default exterior profile: O

## SERIES 32 Category 2



**Model 2132**  
Color: K257S

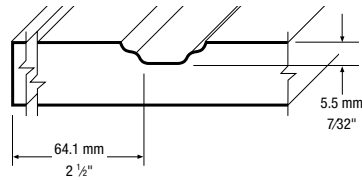

132



232



332



432



**Model 3132**  
Reduced rails

### Minimum dimensions

#### Doors (Height x Width)

Model	mm	inches
2132	173.7 x 173.7	6 27/32 x 6 27/32
2232	188.7 x 173.7	7 7/16 x 6 27/32
2332	213.7 x 173.7	8 7/16 x 6 27/32
2432	$((W \div 2) + 68.8) \times 173.7$	$((W \div 2) + 2 23/32) \times 6 27/32$

#### Drawer fronts (Height x Width)

Model	mm	inches
3132	110.1 x 173.7	4 11/32 x 6 27/32
3232	125.1 x 173.7	4 15/16 x 6 27/32
3332	150.1 x 173.7	5 15/16 x 6 27/32
3432	$((W \div 2) + 5.2) \times 173.7$	$((W \div 2) + 7/32) \times 6 27/32$

W = width

Default exterior profile: C

## STANDARD SPECIFICATIONS

- White melamine back
- The default woodgrain direction is vertical

- Drawer fronts are manufactured with reduced rails (unless regular rails are specified)
- Maximum door height: 2438 mm (96"), maximum door width: 1193 mm (47")

## SERIES 33 Category 3



Model **2133**  
Color: K257S

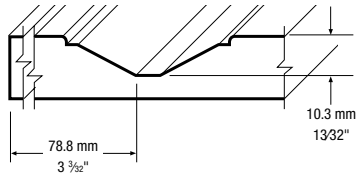

Model **3133**  
Reduced rails

### Minimum dimensions

#### Doors (Height x Width)

Model	mm	inches
2133	225.0 x 225.0	8 7/8 x 8 7/8
2233	240.0 x 225.0	9 15/32 x 8 7/8
2333	265.0 x 225.0	10 7/16 x 8 7/8
2433	$((W \div 2) + 82.5) \times 225.0$	$((W \div 2) + 3 1/4) \times 8 7/8$

#### Drawer fronts (Height x Width)

Model	mm	inches
3133	146.4 x 225.0	5 25/32 x 8 7/8
3233	161.4 x 225.0	6 3/8 x 8 7/8
3333	186.4 x 225.0	7 11/32 x 8 7/8
3433	$((W \div 2) + 3.9) \times 225.0$	$((W \div 2) + 5/32) \times 8 7/8$

W = width  
Default exterior profile: A

## SERIES 39 Category 3



Model **2139**  
Color: K464WT

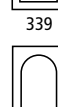
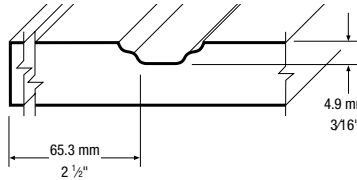

Model **3139**  
Reduced rails

### Minimum dimensions

#### Doors (Height x Width)

Model	mm	inches
2139	175.7 x 175.7	6 15/16 x 6 15/16
2239	190.7 x 175.7	7 17/32 x 6 15/16
2339	215.7 x 200.6	8 1/2 x 7 29/32
2439	$((W \div 2) + 70.0) \times 175.7$	$((W \div 2) + 2 25/32) \times 6 15/16$

#### Drawer fronts (Height x Width)

Model	mm	inches
3139	112.1 x 175.7	4 7/16 x 6 15/16
3239	127.1 x 175.7	5 1/32 x 6 15/16
3339	152.1 x 200.6	6 x 7 29/32
3439	$((W \div 2) + 6.4) \times 175.7$	$((W \div 2) + 9/32) \times 6 15/16$

W = width  
Default exterior profile: C

# STANDARD MODELS

## OPTIONS:

- See availability of same color melamine back, pages 47-48.
- For regular rails drawer fronts, order as a door.

## SERIES 46 Category 3



Model **2146**  
Color: R82S

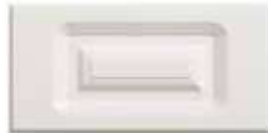
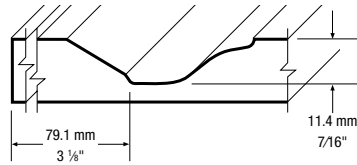

Model **3146**  
Reduced rails

### Minimum dimensions

#### Doors (Height x Width)

Model	mm	inches
2146	234.4 x 234.4	9 1/4 x 9 1/4
2246	254.4 x 234.4	10 1/32 x 9 1/4
2346	284.4 x 234.4	11 7/32 x 9 1/4
2446	$((W \div 2) + 86.5) \times 234.4$	$((W \div 2) + 3 \frac{13}{32}) \times 9 \frac{1}{4}$

#### Drawer fronts (Height x Width)

Model	mm	inches
3146	165.8 x 234.4	6 17/32 x 9 1/4
3246	185.8 x 234.4	7 11/32 x 9 1/4
3346	215.8 x 234.4	8 1/2 x 9 1/4
3446	$((W \div 2) + 17.9) \times 234.4$	$((W \div 2) + 23/32) \times 9 \frac{1}{4}$

W = width  
Default exterior profile: C

## SERIES 47 Category 2



Model **2147**  
Color: A15WT

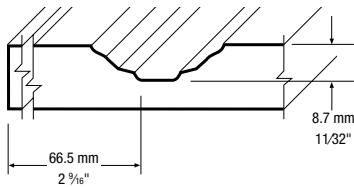

Model **3147**  
Reduced rails

### Minimum dimensions

#### Doors (Height x Width)

Model	mm	inches
2147	185.5 x 185.5	7 5/16 x 7 5/16
2247	200.5 x 185.5	7 29/32 x 7 5/16
2347	228.5 x 210.0	9 x 8 9/32
2447	$((W \div 2) + 69.8) \times 185.5$	$((W \div 2) + 2 \frac{3}{4}) \times 7 \frac{5}{16}$

#### Drawer fronts (Height x Width)

Model	mm	inches
3147	129.5 x 185.5	5 1/8 x 7 5/16
3247	144.5 x 185.5	5 23/32 x 7 5/16
3347	172.5 x 210.0	6 13/16 x 8 9/32
3447	$((W \div 2) + 13.8) \times 185.5$	$((W \div 2) + 9/16) \times 7 \frac{5}{16}$

W = width  
Default exterior profile: C

## STANDARD SPECIFICATIONS

- White melamine back
- The default woodgrain direction is vertical
- Drawer fronts are manufactured with reduced rails (unless regular rails are specified)
- Maximum door height: 2438 mm (96"), maximum door width: 1193 mm (47")

## SERIES 48 Category 3



Model **2148**  
Color: A15WT

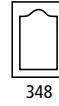
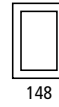
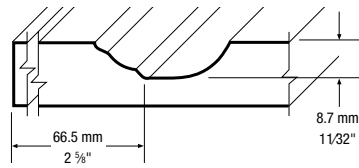

Model **3148**  
Reduced rails

### Minimum dimensions

#### Doors (Height x Width)

Model	mm	inches
2148	187.8 x 187.8	7 13/16 x 7 13/32
2248	202.8 x 187.8	8 x 7 13/32
2348	230.8 x 210.0	9 3/32 x 8 9/32
2448	$((W \div 2) + 73.1) \times 187.8$	$((W \div 2) + 2 29/32) \times 7 13/32$

#### Drawer fronts (Height x Width)

Model	mm	inches
3148	131.8 x 187.8	5 7/32 x 7 13/32
3248	146.8 x 187.8	5 25/32 x 7 13/32
3348	174.8 x 210.0	6 29/32 x 8 9/32
3448	$((W \div 2) + 17.1) \times 187.8$	$((W \div 2) + 1 1/16) \times 7 13/32$

W = width

Default exterior profile: C



# SPECIAL MODELS

## OPTION:

- See availability of same color melamine back, pages 47-48.

## SERIES 911 Category 3



Model **2911**  
Color: K85S

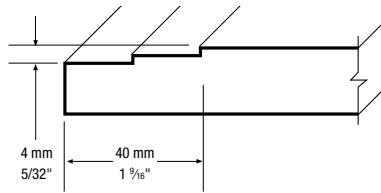

Model **3911**

### Minimum dimensions

Doors and drawer fronts (Height x Width)

Model	mm	inches
2911/3911	92.7 x 92.7	3 21/32 x 3 21/32

Default exterior profile: series 911 is manufactured with its own exterior profile.

## SERIES 921 / 922 / 923 / 924 Cat. 3



Model **2921**  
Color: V66WT

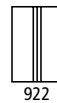
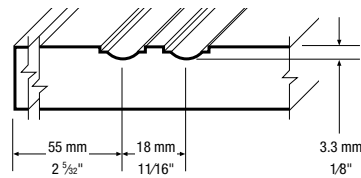

Model **3921**

### Minimum dimensions

Doors (Height x Width)

Model	mm	inches
2921	38.1 x 128.0	1 1/2 x 5 1/16
2922	38.1 x 128.0	1 1/2 x 5 1/16
2923	38.1 x 171.4	1 1/2 x 6 3/4
2924	38.1 x 128.0	1 1/2 x 5 1/16

Drawer fronts (Height x Width)

Model	mm	inches
3921	38.1 x 128.0	1 1/2 x 5 1/16
3922	38.1 x 128.0	1 1/2 x 5 1/16
3923	38.1 x 171.4	1 1/2 x 6 3/4
3924	38.1 x 128.0	1 1/2 x 5 1/16

Default exterior profile: series 921 to 924 are manufactured with their own exterior profile.



## STANDARD SPECIFICATIONS

- White melamine back
- The default woodgrain direction is vertical
- Drawer fronts are manufactured with reduced rails (unless regular rails are specified)
- Maximum door height: 2438 mm (96"), maximum door width: 1193 mm (47")

### SERIES 972 Category 3



Model **2972**  
Color: V66WT

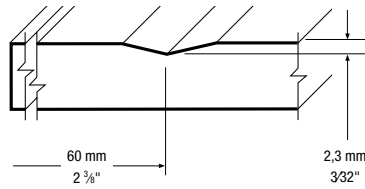

Model **3972**  
Reduced rails



Model **3975**  
Reduced rails

#### Minimum dimensions

##### Doors (Height x Width)

Model	mm	inches
2972	264.2 x 213.7	10 <sup>13</sup> / <sub>32</sub> x 8 <sup>7</sup> / <sub>16</sub>

##### Drawer fronts (Height x Width)

Model	mm	inches
3972	144.2 x 213.7	5 <sup>11</sup> / <sub>16</sub> x 8 <sup>7</sup> / <sub>16</sub>
3975	144.2 x 273.1	5 <sup>11</sup> / <sub>16</sub> x 10 <sup>3</sup> / <sub>4</sub>

Default exterior profile: B

### SERIES 974 Category 4



Model **2974**  
Color: K85S

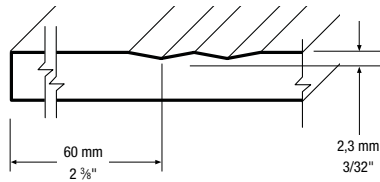

Model **3974**  
Reduced rails

#### Minimum dimensions

##### Doors (Height x Width)

Model	mm	inches
2974	213.7 x 213.7	8 <sup>7</sup> / <sub>16</sub> x 8 <sup>7</sup> / <sub>16</sub>

##### Drawer fronts (Height x Width)

Model	mm	inches
3974	164.2 x 213.7	6 <sup>15</sup> / <sub>32</sub> x 8 <sup>7</sup> / <sub>16</sub>

Default exterior profile: B

# SPECIAL MODELS

## STANDARD SPECIFICATIONS

- White melamine back
- The default woodgrain direction if vertical

- Drawer fronts are manufactured with reduced rails (unless regular rails are specified)
- Maximum door height: 2438 mm (96"), maximum door width: 1193 mm (47")

## SERIES 996 Category 3



Model **2996**  
Color: A661S



Model **3996**

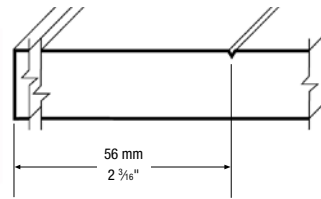

### FRAME DOOR

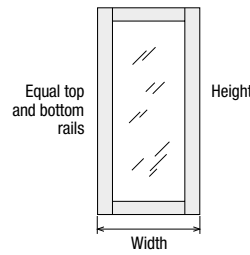

### Minimum dimensions

Doors and drawer fronts (Height x Width)

Model	mm	inches
2996/3996	38.1 x 162.8	1 1/2 x 6 7/16

Note: Not available with exterior profiles D, F, H and P.  
Default exterior profile: Y

The first groove is 48 mm (1-57/64") from the top of the door. Door rails height vary according to door dimensions.

### ALIGNMENT OF ADJACENT DOORS AND DRAWERS

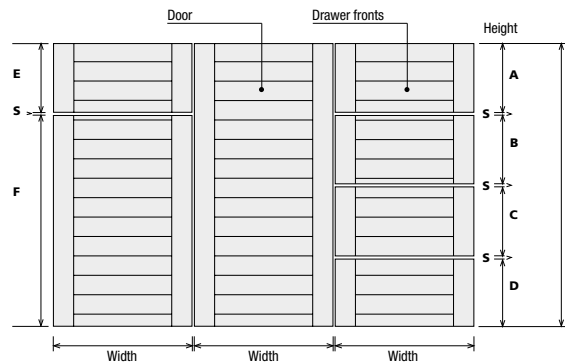

A, B, C, D, E, F and G: height of doors and drawers. / S: vertical space required between drawers.  
To align the grooves with other doors and drawers front, please specify it when ordering and provide us a drawing.

### VERTICAL CROSS SECTION

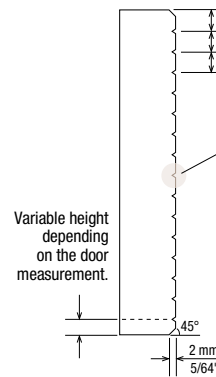

### HORIZONTAL CROSS SECTION

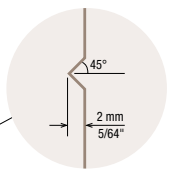

## SERIES 939 Category 3



Model **2939**  
Color: A4WT

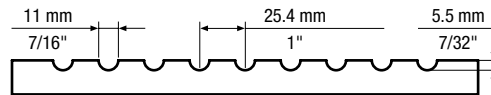

The first groove starts at the center of the door.

### Minimum dimensions

Doors (Height x Width)

Model	mm	inches
2939	76.2 x 76.2	3 x 3

Default exterior profile: Q

The width of the stiles vary according to door dimensions.

# GROOVES ON CENTER PANELS



Color: K464WT



Single Vertical Grooves

If you require vertical grooves on your center panel, please choose this option when you place your order.

The vertical groove options on center panel are available on most door models. Please contact Customer Service for more information.

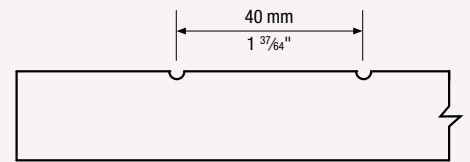

Color: K464WT



Double Vertical Grooves

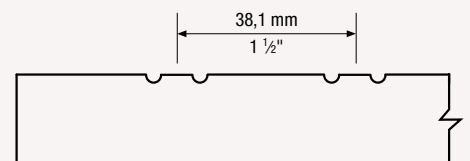



# PERSONALIZED SIGNATURE

FRAME AND  
MULLION DOORS

PANELS

MOULDINGS

ACCESSORIES

TECHNICAL  
SPECIFICATIONS

# FRAME AND MULLION DOORS



Model **4101**  
Color: V67WT

## Standards

### SERIES 4100

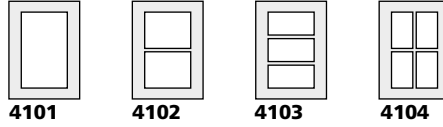

**4101 4102 4103 4104**

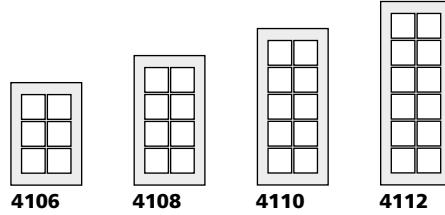

**4106 4108 4110 4112**

### SERIES 4200

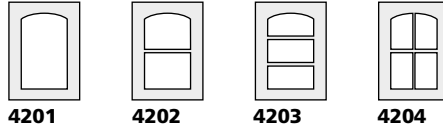

**4201 4202 4203 4204**

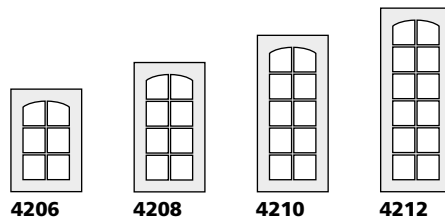

**4206 4208 4210 4212**

### SERIES 4300

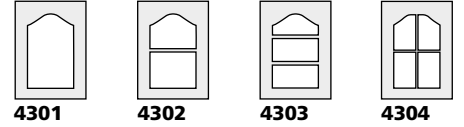

**4301 4302 4303 4304**

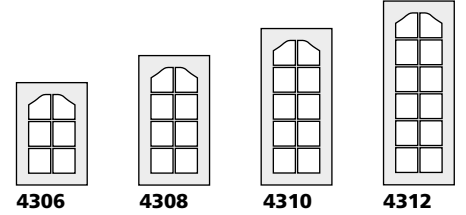

**4306 4308 4310 4312**

### SERIES 4400

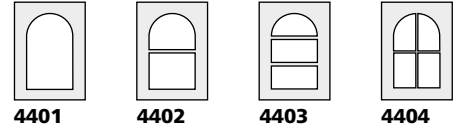

**4401 4402 4403 4404**

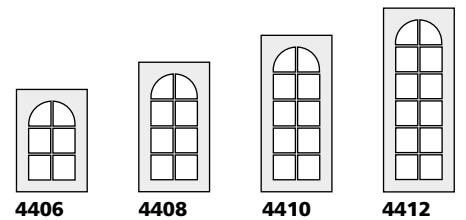

**4406 4408 4410 4412**



Model **4106**  
Color: V67WT

## Specials

### SERIES 6300-6400

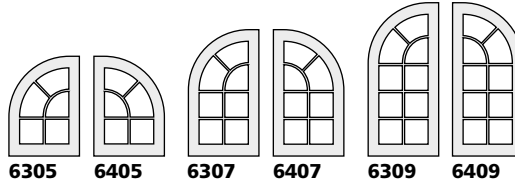

**6305 6405 6307 6407 6309 6409**

### SERIES 6700

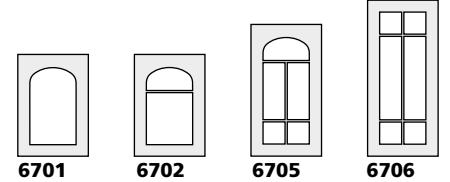

**6701 6702 6705 6706**

### SERIES 6500-6600

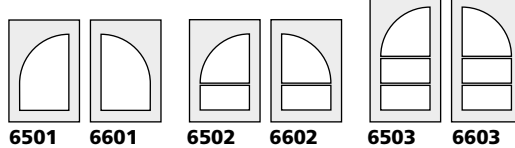

**6501 6601 6502 6602 6503 6603**

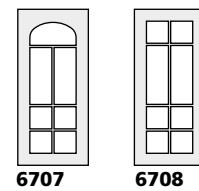

**6707 6708**

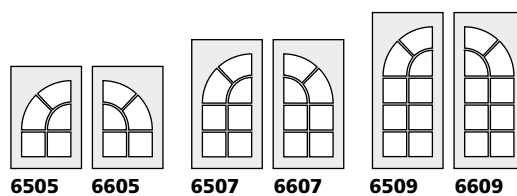

**6505 6605 6507 6607 6509 6609**

### SERIES 6900

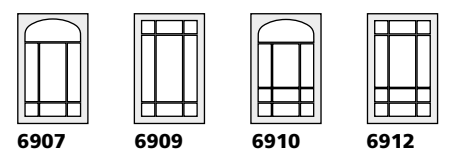

**6907 6909 6910 6912**

# FRAME AND MULLION DOORS

## OPTION:

MDF core will be visible on the back of the frame or mullion door. It can be painted on request.

## SPECIFICATIONS

- 1) For special frame and mullion doors (except series 6900), the door widths must be identical.
- 2) An interior profile must be specified for frame and mullion doors ordered with models 00, 79, 80, 910 (default profile 51) and 911, 912 (default profile 09).
- 3) Series 83 to 89 are only available in special mullion door models 6706, 6708, 6909 and 6912. This restriction does not apply to series 93 to 99.
- 4) Models 942 and 996 frame and mullion doors are available only in 4100 series.

## Glass insert sizes

Model	Height		Width	
	mm	inches	mm	inches
01-03-04-06-07-27-31-33-46-71-73-974	H - 115	H - 4 1/2	W - 115	W - 4 1/2
08-09-32-39-47-48-49-50-51-52-55-56-58-70-72-76-77-78-83-85-86-87-88-89-93-95-96-97-98-99-167-767-942-972	H - 102	H - 4	W - 102	W - 4
921-922-924	H - 91	H - 3 9/16	W - 127	W - 5
923	H - 91	H - 3 9/16	W - 163	W - 6 7/16
996	H - 88	H - 3 1/2	W - 102	W - 4
41-61-62-65-66-164-764	H - 127	H - 5	W - 127	W - 5

H = Height W = width

## SPECIFICATIONS

Suggested glass thickness: 3 mm (1/8") to 5 mm (3/16").

For glass over 1219 mm (48"), glass thickness of 5 mm (3/16") is suggested.

## Glass Retainer Moulding

Model	Colors
5351	Clear
5350	White



## GLASS INSTALLATION

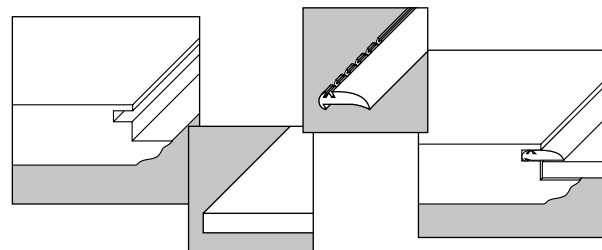

## Minimum dimensions

Lites	Height x Width	
	mm	inches
01	203.2 x 203.2	8 x 8
02	279.4 x 203.2	11 x 8
03	368.3 x 203.2	14 1/2 x 8
04	279.4 x 279.4	11 x 11
06	368.3 x 279.4	14 1/2 x 11
08	457.2 x 279.4	18 x 11
10	546.1 x 279.4	21 1/2 x 11
12	635.0 x 279.4	25 x 11

Lites	Height x Width
	*
02	≥ W
03	≥ 1.4 x W
04	≥ W
06	≥ 1.4 x W
08	≥ 1.8 x W
10	≥ 2.2 x W
12	≥ 2.6 x W

\* Frames 4401 have the same minimum dimensions as their corresponding door model (ex.: 401, etc.).

Series	Width
	6305 - 6405
6307 - 6407	≥ 1.6 x W
6309 - 6409	≥ 2 x W
6501 - 6601	≥ W
6502 - 6602	≥ 1.4 x W
6503 - 6603	≥ 1.6 x W
6505 - 6605	≥ 1.4 x W
6507 - 6607	≥ 1.6 x W
6509 - 6609	≥ 2.0 x W

The center of the radius is not calculated from the door rail. Please contact Customer Service for more information.

Series	Width	
	6701	≥ 0.6 x W
6702	≥ 0.9 x W	
6705	≥ 1.5 x W	
6706	≥ 1.5 x W	
6707	≥ 1.9 x W	
6708	≥ 1.9 x W	

Series	Height x Width	
	6907	500 x 444.5
6909	425 x 444.5	16 3/4 x 17 1/2
6910	600 x 444.5	23 5/8 x 17 1/2
6912	525 x 444.5	20 11/16 x 17 1/2

## Multiple Panels

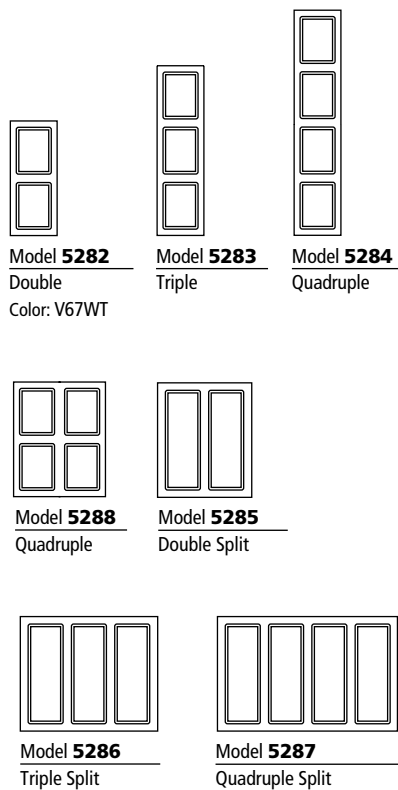

## Appliance Panels

Appliance panels are available in the same models as the doors and multiple panels. However, their exterior is modified, as shown, to simplify their insertion.

Exterior profile **A** in this example.  
Available exterior profiles: A, B, C, F, I, J, L, Y

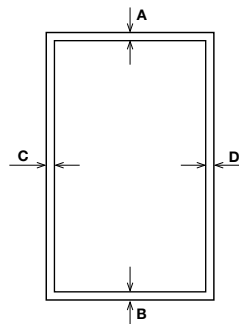
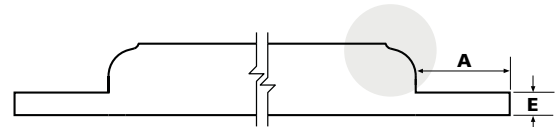

Model **5270**  
Simple

### SPECIFICATIONS

Values from **A** to **E** must be specified. If not specified, default value for **E** will be 6.35 mm (1/4"). Minimum thickness for **E** is 4.76 mm (3/16").

### AVAILABLE MODELS

- Simple (5270)
- Double (5272)
- Double Split (5275)
- Triple (5273)
- Triple Split (5276)
- Quadruple (5274, 5278)
- Quadruple Split (5277)

## Frame for built-in appliances



Model **5566**  
Color: R205W

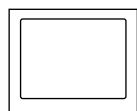

Model **5560**

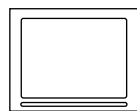

Model **5561**

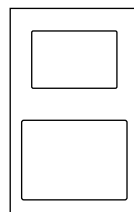

Model **5567**

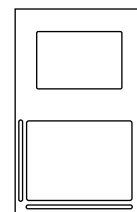

Model **5569**

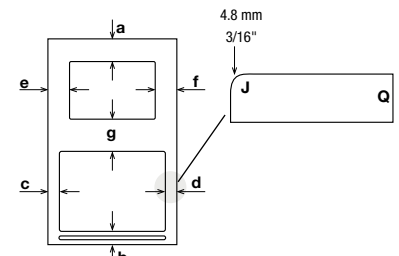

Model **5568**

### SPECIFICATIONS

- 1) Inner and outer frame are available in all exterior profiles. Profiles by default are **J** for the interior profile and **Q** for the exterior profile.
- 2) Vents are centered on the height and width of the rail.
- 3) Minimum rails dimensions:
  - with vent, 50 mm (2");
  - without vent, 38.1 mm (1 1/2")
- 4) For models 5567, 5568 and 5569, please specify at least 1 opening height.



# MOULDINGS AND ACCESSORIES

## Thermoplastic Laminated Panels

### Laminated particle board panels – Unilam (Phenolic paper)

#### ONE SIDE: THERMO FRONT / UNILAM BACK

- 5011 : 15.86 mm x 1.2 m x 2.7 m (5/8" x 4' x 9')
- 5013 : 15.86 mm x 1.2 m x 2.4 m (5/8" x 4' x 8')
- 5015 : 19.05 mm x 1.2 m x 2.4 m (3/4" x 4' x 8')

#### BOTH SIDES: THERMO FRONT / THERMO BACK

- 5010 : 15.86 mm x 1.2 m x 2.7 m (5/8" x 4' x 9')
- 5012 : 15.86 mm x 1.2 m x 2.4 m (5/8" x 4' x 8')
- 5019 : 19.05 mm x 1.2 m x 2.4 m (3/4" x 4' x 8')

### Laminated MDF Panels – MDF (one side)

#### THERMO FRONT / RAW MDF BACK

- 5014 : 6.3 mm x 1.2 m x 2.4 m (1/4" x 4' x 8')
- 5018 : 3.18 mm x 1.2 m x 2.4 m (1/8" x 4' x 8')
- 5027 : 19.05 mm x 1.2 m x 2.7 m (3/4" x 4' x 9')

### Laminated MDF Panels (Both sides)

#### THERMO FRONT / THERMO BACK

- 5017 : 19.05 mm x 1.2 m x 2.7 m (3/4" x 4' x 9')
- 5026 : 15.86 mm x 1.2 m x 2.4 m (5/8" x 4' x 8')

### Laminated Melamine Panels – Melamine (one side)

#### THERMO FRONT / MELAMINE BACK

- 5016 : 19.05 mm x 1.2 m x 2.7 m (3/4" x 4' x 9')
- 5024 : 15.86 mm x 1.2 m x 2.7 m (5/8" x 4' x 9')
- 5025 : 15.86 mm x 1.2 m x 2.4 m (5/8" x 4' x 8')

Note: See pages 47-48 for specifications and colors availability.

## Wine Racks

### CIRCLE OPENINGS



Model **5132**  
Color: F435WT



Model **5133**  
Color: F435WT

### SPECIFICATIONS

- If models 5132 and 5133 are paired together, it must be specified when placing your order.
- Minimum dimensions:  
5132: 76.2 mm (3") height  
5133: 69.8 mm (2 3/4") height



Model **5134**  
Color: F435WT

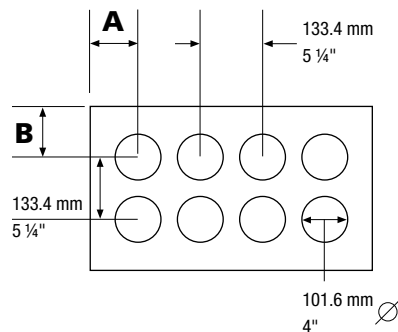

### SPECIFICATIONS

- 1) Standard opening diameter: 101.6 mm (4")
- 2) Distance from the center of one opening to the center of the next.: 133.4 mm (5 1/4")
- 3)  $A = \frac{\text{Width} - (\text{number of holes} - 1) \times 133.4 \text{ mm}}{\text{Width} - (\text{number of holes} - 1) \times 5 \frac{1}{4} \text{''}} \div 2$   
 $B = \frac{\text{Height} - (\text{number of holes} - 1) \times 133.4 \text{ mm}}{\text{Height} - (\text{number of holes} - 1) \times 5 \frac{1}{4} \text{''}} \div 2$
- 4) **A** or **B** minimum dimension: 76.2 mm (3")

Model **5138**  
Color: F435WT

### DIAMOND OPENINGS



Model **5141**  
Color: R205W



Model **5142**  
Color: R205W



Model **5143**  
Color: R205W

### SPECIFICATIONS

Opening size: 101.6 x 101.6 mm (4" x 4")

Product	Number of openings	Minimum dimension		Maximum dimension	
		mm	in.	mm	in.
<b>5134/5138</b>	1	152.4	6	285.7	11 1/4
	2	285.8	11 1/4	419.0	16 1/2
	3	419.1	16 1/2	501.6	19 3/4
	4	552.5	21 3/4	685.7	27
	5	685.8	27	819.1	32 1/4
	6	819.2	32 1/4	952.4	37 1/2
<b>5141/5142</b>	1	239.4	9 3/8	427.9	16 7/8
	2	428.0	16 7/8	616.5	24 1/4
	3	616.6	24 1/4	805.0	31 3/4
	4	805.1	31 3/4	993.6	39 1/8
	5	993.7	39 1/8	1182.2	46 1/2
	6	1182.3	46 1/2	1370.8	54
<b>5143</b>	1	194.5	7 3/8	383.0	15 1/8
	2	383.1	15 1/8	571.6	22 1/2
	3	571.7	22 1/2	760.1	29 7/8
	4	760.2	29 7/8	948.7	37 3/8
	5	948.8	37 3/8	1137.3	44 3/4
	6	1137.4	44 3/4	1325.9	52 1/4

# MOULDINGS AND ACCESSORIES

## Decorative Mouldings

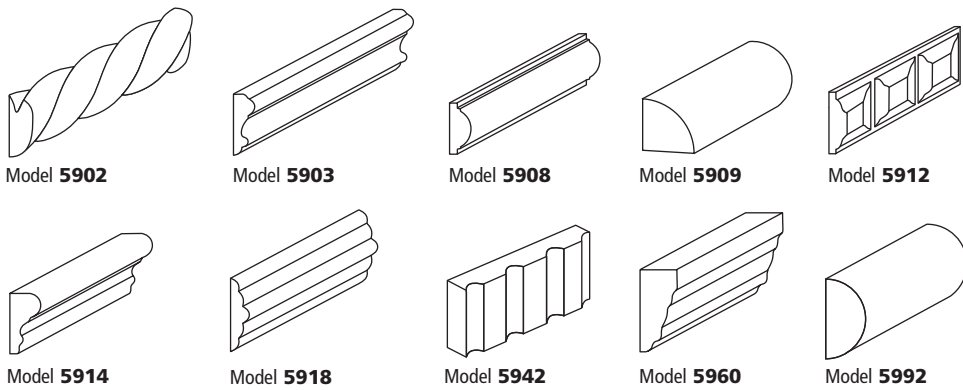

Model	Height x Thickness	
	mm	inches
5767	40.6 x 15.2	1 5/8 x 5/8
5902	17.5 x 7	11/16 x 9/32
5903	20.6 x 6.4	13/16 x 1/4
5908	19 x 8	3/4 x 5/16
5909	19 x 19	3/4 x 3/4
5912	22.2 x 8	7/8 x 5/16
5914	25.4 x 12	1 x 15/32
5918	27 x 6.4	1 1/16 x 1/4
5942	25.4 x 19	1 x 3/4
5960	35 x 16	1 3/8 x 5/8
5992	38 x 19	1 1/2 x 3/4

### SPECIFICATIONS

- 1) Available in 2.4 m (8') lengths.
- 2) Definition of certain details varies according to the thickness of the thermoplastic foil.
- 3) Models 5902 and 5912 come in 2.38 m (94") lengths.

## Trim Moulding

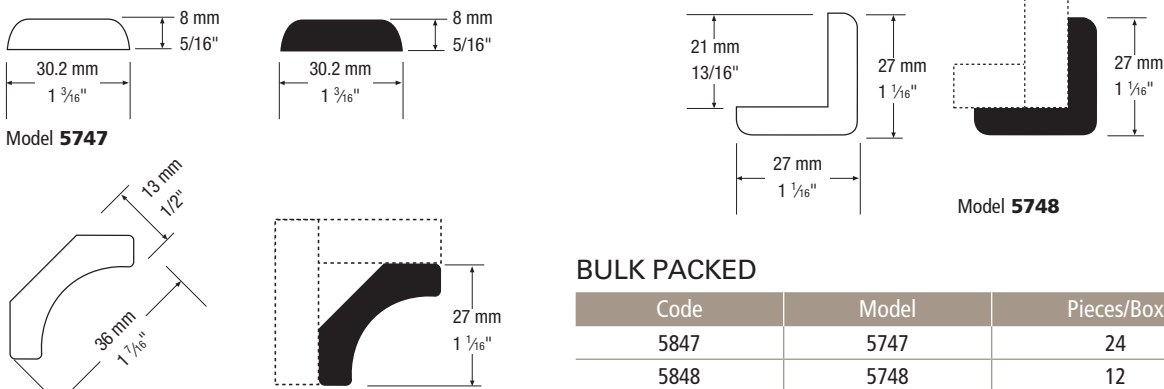

### BULK PACKED

Code	Model	Pieces/Box
5847	5747	24
5848	5748	12
5858	5758	2

NOTE: Certain Color restrictions apply. Please consult price list.

## Decorative moulding

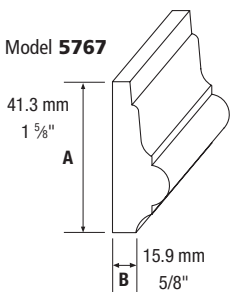

Model 5767

41.3 mm  
1 5/8"  
A  
15.9 mm  
5/8"  
B

## Decorative Base

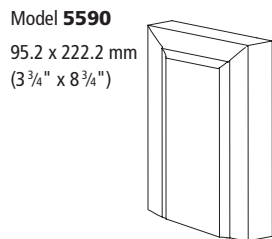

Model 5590

95.2 x 222.2 mm  
(3 3/4" x 8 3/4")

## Decorative corner



Model 5531

### Minimum dimensions

Decorative corner Height x Thickness		
Épaisseur	mm	inches
3/4"	76.2 x 76.2	3 x 3
1"	76.2 x 76.2	3 x 3

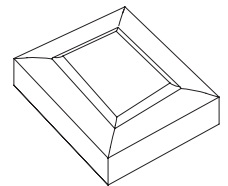

Model 5540

95.2 x 95.2 mm  
(3 3/4" x 3 3/4")

## Baseboards

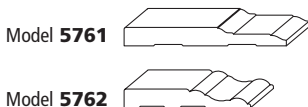

Model 5761

Model 5762

Model	Height x Thickness	
	mm	inches
5760	165.1 x 15.2	6 1/2 x 5/8
5761	139.7 x 15.2	5 1/2 x 5/8
5762	108 x 15.2	4 1/4 x 5/8

## Frame mouldings

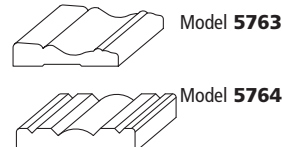

Model 5763

Model 5764

Model	Height x Thickness	
	mm	inches
5763	68.3 x 15.2	2 11/16 x 5/8
5764	79.4 x 15.2	3 1/8 x 5/8

# MOULDINGS AND ACCESSORIES

## Crown mouldings

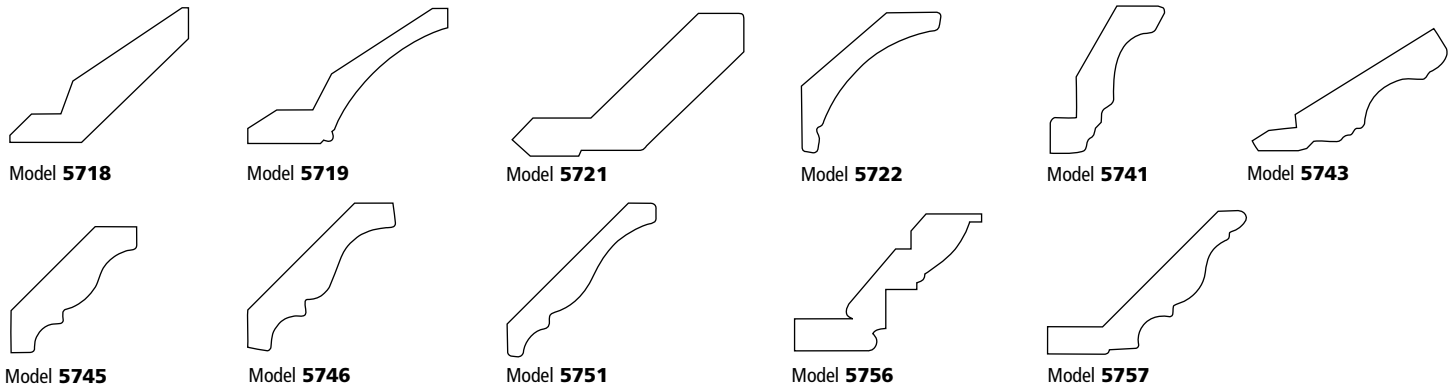

Model	Height x Thickness	
	mm	inches
5718	99.1 x 24.6	3 15/16 x 3 1/2
5719	99.1 x 25	3 15/16 x 1
5721	65.1 x 19.1	2 9/16 x 3/4
5722	102.25 x 31.71	4 x 3/4
5741	76.2 x 17.5	3 x 1 1/16
5743	90.5 x 17.5	3 9/16 x 1 1/16
5745	69.9 x 17	2 3/4 x 43/64
5746	80.2 x 17.5	3 5/32 x 1 1/16
5751	108 x 15	4 1/4 x 19/32
5756	88.9 x 19.1	3 1/2 x 3/4
5757	139.7 x 30	5 1/2 x 1 1/64

### SPECIFICATIONS

- Available in 2.4 m (8') lengths.
- Available in all colors.

### BULK PACKED

Code	Model	Pieces/Box
5841	5741	4
5843	5743	4
5845	5745	4
5846	5746	4
5856	5756	2
5857	5757	2

Note: some Color restrictions apply. Please consult price list.

## Installation

### METHOD 1

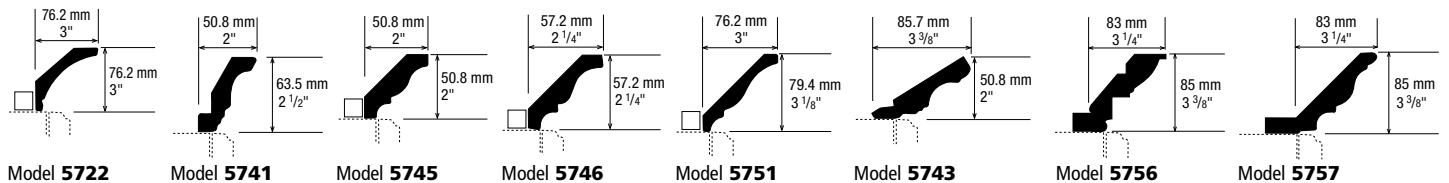

### METHOD 2

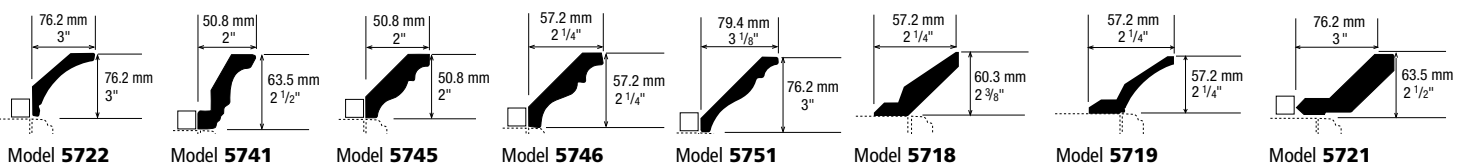

Crown mouldings should be glued and clamped rather than nailed.

# MOULDINGS AND ACCESSORIES

## 3" Standard Valances

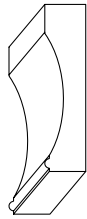
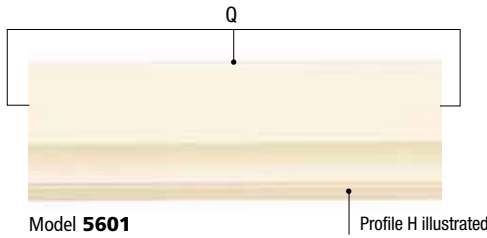

### SPECIFICATIONS

- 1) Standard valances are 76.2 mm (3") high with the bottom edge profiled.
- 2) All exterior profiles are available. (See page 2)
- 3) 5601 (profiled 1 side), 5602 (profiled 2 sides) = 76.2 mm (3")
- 4) Woodgrain direction is horizontal.

- 5) To order flat customized fillers, base mouldings or valances, order product 2000 and 3000.
- 6) Minimum charge of 0.19 sq.m (2 sq.ft) for thermoplastic valances whose height or width is less than 76.2 mm (3") and whose length is greater than 1828 mm (72").

## Custom Valances



Model **5610**  
Color: C72R



Model **5620**  
Color: C72R



Model **5631**  
Color: C72R



Model **5640**  
Color: C72R



Model **5650**  
Color: C72R

## Valances (Designer Series)



Model **5510**  
Country Manor

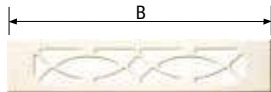

Model **5520**  
Country Cottage

Model	Minimum dimensions				Standard dimensions			
	A		B		A		B	
	mm	in.	mm	in.	mm	in.	mm	in.
5510 Country Manor	152	6	235	9 1/4	152	6	762	30
5520 Country Cottage	152	6	304.8	12	152	6	762	30

### SPECIFICATIONS

- 1) Back routing is identical to frame and mullion doors.
- 2) Model 5520 "Eye Shaped" pattern repeated every 355.6 mm (14").
- 3) All profiles available except D, F, H and P.
- 4) If width < 44", woodgrain direction is vertical.
- 5) If width > 44", woodgrain direction is horizontal.

## Standards

Custom valance standard dimensions have been established as shown below.

Therefore, custom valances ordered outside of these standards will require special programming.

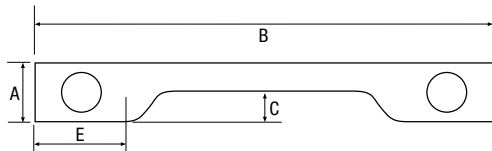

Models **5610-5611-5616**

- If  $B < 609.6$  mm (24"),  $E = 76.2$  mm (3")
- If  $B \geq 609.6$  mm (24"),  $E = 152.4$  mm (6")
- If  $A < 203.2$  mm (8"),  $C = 50.8$  mm (2")
- If  $A \geq 203.2$  mm (8"),  $C = 101.6$  mm (4")

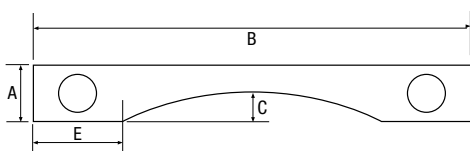

Models **5620-5621-5626, 5630-5631-5636**

- $E$  is variable
- If  $B < 508$  mm (20"),  $E$  minimum size is 76.2 mm (3") and  $E$  maximum size is 101.6 mm (4")
- If  $B \geq 508$  mm (20"),  $E$  minimum size is 76.2 mm (3") and  $E$  maximum size is 165.1 mm (6 1/2")
- If  $A < 203.2$  mm (8"),  $C = 50.8$  mm (2")
- If  $A \geq 203.2$  mm (8"),  $C = 101.6$  mm (4")

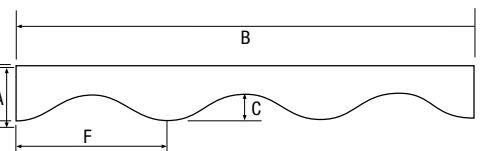

Models **5640**

- If  $B < 762$  mm (30"),  $F = 127$  mm (5") and  $C = 25.4$  mm (1")
- If  $B \geq 762$  mm (30"),  $F = 254$  mm (10") and  $C = 50.8$  mm (2")

### Minimum dimensions

Model	A		B	
	mm	in.	mm	in.
5610 plain	101,6	4	330,2	13
5611 with 2 routed circles	101,6	4	330,2	13
5616 with 2 applied rosette	101,6	4	330,2	13
5620 plain	101,6	4	304,8	12

Model	A		B	
	mm	in.	mm	in.
5621 with 2 routed circles	101,6	4	304,8	12
5626 with 2 applied rosette	101,6	4	304,8	12
5630 plain	101,6	4	304,8	12
5631 with 2 routed circles	101,6	4	304,8	12

Model	A		B	
	mm	in.	mm	in.
5636 with 2 applied rosette	101,6	4	304,8	12
5640 plain	101,6	4	254	10
5650 plain	101,6	4	152,4	6

### SPECIFICATIONS

- 1) Only the bottom edge is profiled. Please specify the edge profile.
- 2) Rosettes are centred vertically in the  $A$  dimension and horizontally in the  $E$  dimension.
- 3) Woodgrain pattern is horizontal. (Exeptions may apply, please contact Customer Service for further information.)

# MOULDINGS AND ACCESSORIES

## Rosettes



Model **5530**  
Color: C72R



Model **5580**  
Color: C72R

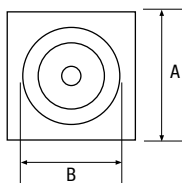

### Standard dimensions

Model	A		B		C	
	mm	in.	mm	in.	mm	in.
5530 circle route	76.2	3	68	2 11/16	19.1 – 25	3/4 – 1
5580 applied rosette	76.2	3	63.5	2 1/2	19.1 – 25	3/4 – 1

### SPECIFICATIONS

- 1) Not available with exterior profiles: **H**, **P** and **V**.
- 2) A minimum of 88.9 mm (3 1/2") is required for all profiles except **Q** and **Y**.
- 3) Available with white back only.

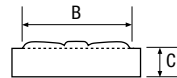
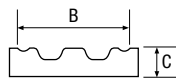

## 3" Radius Corners



Model **5300** Standard lengths 800 mm (31 1/2")

Model **5310** Standard lengths 2440 mm (96")

### SPECIFICATIONS

- 1) Standard lengths: 800 mm (31 1/2"), 2440 mm (96"). Custom lengths also available as an option.

## Shaker Filler

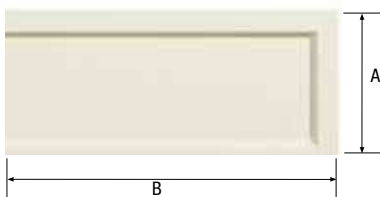

Model **5450**  
Color: C72R

### Standard dimensions

Model	A		B	
	mm	in.	mm	in.
5450	76.2	3	813	32

### SPECIFICATIONS

- 1) Default exterior profile: **Q**.
- 2) Not available with exterior profiles: **H**, **P** and **V**.
- 3) Different lengths are available on request for **A** and **B**.

## Fillers



### Standard dimensions

Model	Description	A		B		C		D		E		F	
		mm	in.	mm	in.	mm	in.	mm	in.	mm	in.	mm	in.
5400	plain	76.2	3	–	–	813	32	–	–	–	–	–	–
5401	with 2 routed circles	76.2	3	114.3	4 1/2	813	32	–	–	–	–	68	2 11/16
5406	with 2 applied rosettes	76.2	3	114.3	4 1/2	813	32	–	–	–	–	63.5	2 1/2
5410	1 staggered groove	76.2	3	–	–	813	32	–	–	50.8	2	–	–
5411	1 staggered groove with 2 routed circles	76.2	3	114.3	4 1/2	813	32	177.8	7	50.8	2	68	2 11/16
5416	1 staggered groove with 2 applied rosettes	76.2	3	114.3	4 1/2	813	32	177.8	7	50.8	2	63.5	2 1/2
5420	2 grooves	76.2	3	–	–	813	32	177.8	7	–	–	–	–
5421	2 grooves with 2 routed circles	76.2	3	114.3	4 1/2	813	32	177.8	7	–	–	68	2 11/16
5426	2 grooves with 2 applied rosettes	76.2	3	114.3	4 1/2	813	32	177.8	7	–	–	63.5	2 1/2
5429	2 full length grooves	76.2	3	–	–	813	32	–	–	–	–	–	–
5430	3 grooves	76.2	3	–	–	813	32	177.8	7	–	–	–	–
5431	3 grooves with 2 routed circles	76.2	3	114.3	4 1/2	813	32	177.8	7	–	–	68	2 11/16
5436	3 grooves with 2 applied rosettes	76.2	3	114.3	4 1/2	813	32	177.8	7	–	–	63.5	2 1/2
5439	3 full length grooves	76.2	3	–	–	813	32	–	–	–	–	–	–

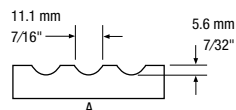
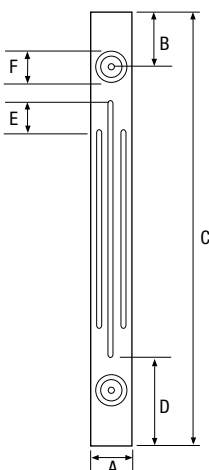

Note: If **C** is < 609,6 mm (24")

**B** = 38,1 mm (1 1/2")

**D** = 101,6 mm (4")

**E** = 25,4 mm (1")

### SPECIFICATIONS

- 1) Default exterior profile: **Q**.
- 2) Not available with exterior profiles: **H**, **P** and **V**.
- 3) The ratio is one groove per inch unless specified otherwise.
- 4) Different lengths are available on request for **A**, **B**, **C**, **D**, **E**.

# MOULDINGS AND ACCESSORIES

## Heatshield Fillers

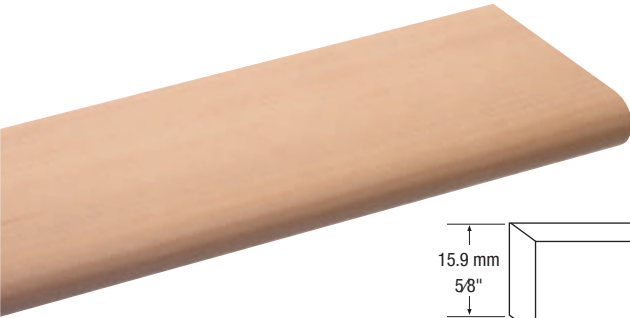

**Heatshield fillers** are high-heat-resistant fillers/spacers for kitchen cabinet installations near a heat source. **HPL Heatshield fillers** are postformed components with a 180° profile, subjected to pretesting at temperatures exceeding 120°C (250°F) without delamination

Produced with compatible HPL, they are available in most colors. Please contact Customer Service for an up-to-date list of available colors..

### SPECIFICATIONS

Model	m	ft
5315	1.2	4
5316	2.4	8

A 25.4 mm (1") HPL strip is supplied with each heatshield filler. After cutting the heatshield filler to size, use the edgebanding strip to finish the ends.

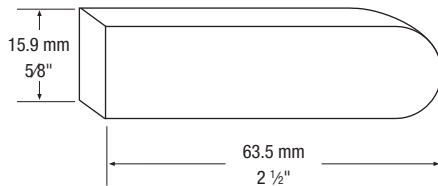

## Installation

### CLEAR PLASTIC HEATSHIELD FILLERS

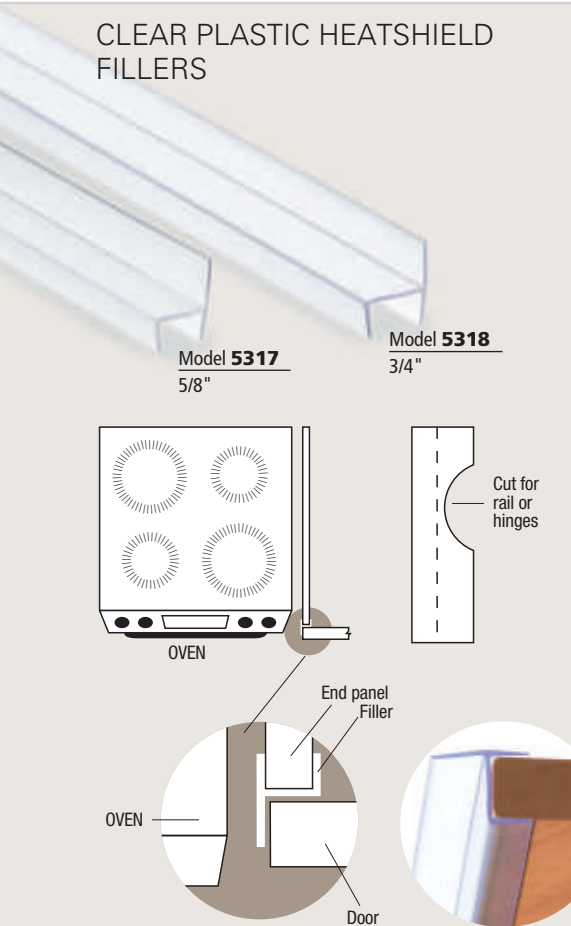

The clear plastic heatshield is a great option for cabinet installation close to a heat source. With the same resistance to heat as the HPL Heatshield fillers (250 °F / 120 °C), this clear plastic heatshield is compatible with all thermoplastic colors. It is easily installed along the edge of the end panel and requires no adhesive. If installing the heatshield around hinges or rails, a simple cut on the interior of the heatshield is sufficient.

### WALL MOUNTED OVENS

The use of heatshield fillers is recommended, as mentioned for base ovens and cooktops. In addition, a 5/8"-3/4" filler should be fitted horizontally between the oven and the top door, aligned with the door surface.

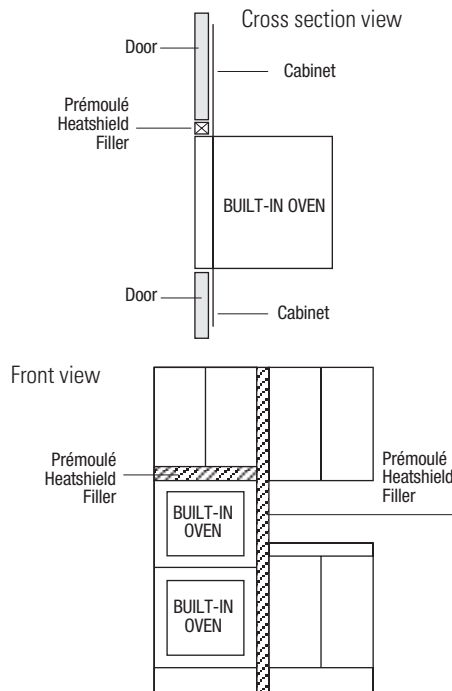

### BASE OVENS AND COOK TOPS

The heatshield filler must be mounted so that its surface is aligned with the adjacent door surface. The same recommendation applies to cook tops with front exhaust vents. The filler act as a shield against excessive radiant and convective heat associated with broiling (with the oven door open) and ovens with self-cleaning features.

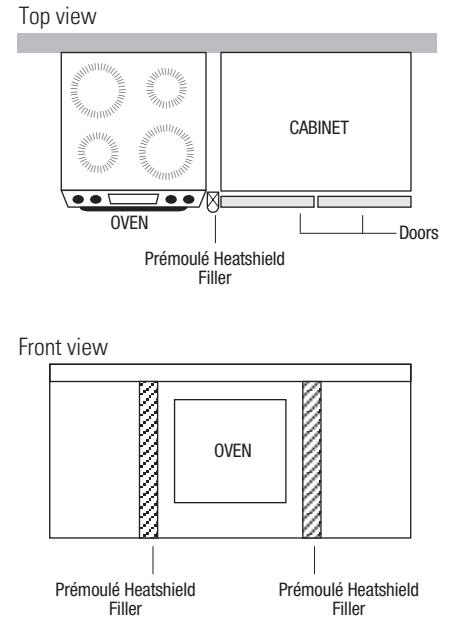

### WALL MOUNTED MICROWAVE OVENS AND UNDERMOUNT COFFEE MAKERS

The heatshield filler mounted flush, or protruding slightly beyond the face surfaces of doors above, is recommended. This precludes possible surface damage and swelling of core material from excessive heat and/or steam.

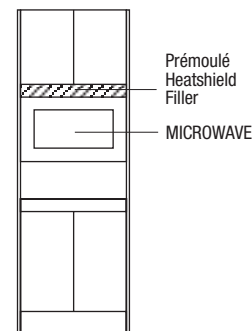

### RESTRICTION

**Counter top appliances:** Care must be taken when using toasters, toaster ovens, portable grills and other heat/steam generating appliances to ensure that upper cabinet doors are not subjected to excessive temperatures



# MOULDINGS AND ACCESSORIES

## Corner Shelves

### SHELF WITH RADIUS



Model **5120**

NOTE: Same Color melamine back available.

### SHELF WITH ELLIPSE



Model **5121**

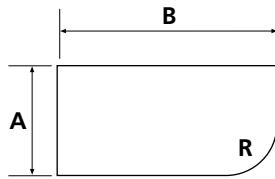

If **A** or **B** < 203.2 mm (8"), **R** = 88.9 mm (3 1/2")

If **A** and **B** ≥ 203.2 mm (8"), **R** = 190.5 mm (7 1/2")

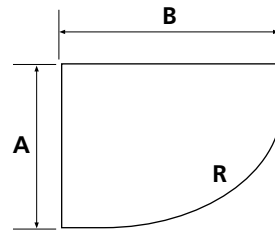

If **A** or **B** sizes are between:

101.6 mm (4") – 152.4 mm (6"), **R** = 101.6 mm (4")

152.4 mm (6") – 203.2 mm (8"), **R** = 152.4 mm (6")

203.2 mm (8") – 254 mm (10"), **R** = 203.2 mm (8")

254 mm (10") – 381 mm (15"), **R** = 254 mm (10")

NOTE: Minimum size for **A** and **B** is 89 mm (3 1/2")

## Decorative Tambours

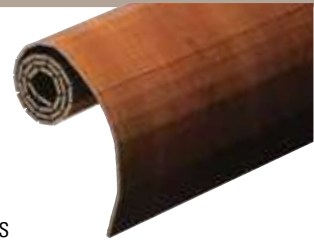

### Available dimensions

Model Thickness 3.2 mm x 1/8 in.	Model Thickness 6.4 mm x 1/4 in.	m	pi.
5005	5005	0.6 x 0.6	2 x 2
5003	5052	0.6 x 1.2	2 x 4
5054	5054	1.2 x 1.2	4 x 4

### SPECIFICATIONS

- Strip width: 12.7 mm (1/2")  
First strip: 38.1 mm (1 1/2")
- The default woodgrain direction is vertical.  
Horizontal woodgrain available as an option.

## Thermoplastic Foil

Thermoplastic sheet  
Length must be specified

- 5000: 1.2 m (4') wide.

Peel and stick

- 5040: 1.2 m x 2.4 m (4' x 8')  
Length must be specify

Thermoplastic on phenolic

- 5060: 1.2 m x 2.4 m (4' x 8')

Note: See pages 47-48 for the available colors.

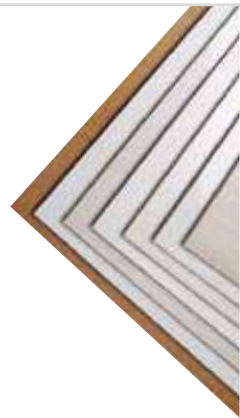

## Edgebanding

Our thermoplastic edgebanding is formulated to be used with edgebanding machines operating at 77 °C (170 °F). Since standard edgebanding machines run at 88 °C (190 °F) to 99 °C (210 °F), we also offer PVC edgebanding which can be applied with the standard machines. Available finishes for each type of edgebanding are listed in the table on page 47-48.

### Thermoplastic Edgebanding

- 25.4 mm (1") wide
- 100 m (328') roll (5008)
- 2.4 m (8') length (5009)

### PVC Edgebanding

- 23.8 mm (1 5/16") wide
- 236.2 m (600') roll (5050)

### SPECIFICATIONS

- Our warranty is applicable on thermoplastic products and does not apply to PVC edgebanding.
- If PVC edgebanding is applied manually, we recommend using a high quality water-based contact cement to avoid damaging adjacent thermoplastic surfaces.



## End Panels

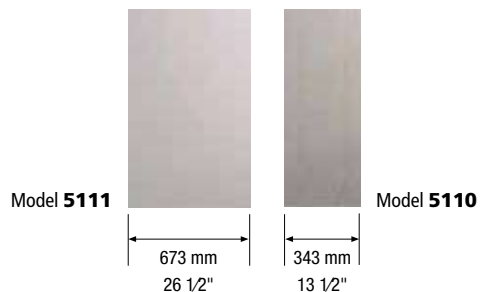

### Available dimensions

Model 1 face	Model 2 faces	mm	in.
5110	5116	343 x 2440	13 1/2 x 96
5111	5117	673 x 2440	26 1/2 x 96

### SPECIFICATIONS

- All exterior profiles available
- Custom dimensions also available.



# TECHNICAL SPECIFICATIONS

## Product Properties

### Height and width tolerance

- $\pm 0.5$  mm (0.020")

### Warp tolerance per linear foot

- $\pm 0,8$  mm (1/32"). Refer to page 47 for recommended hinge holes.

### Heat resistance

- 85 °C (185 °F). See page 44 for installation near heat sources.

## Product Care and Maintenance

Thermoplastic doors can be easily cleaned with mild soap and water. However, as with any quality product, there are certain precautions you can take to preserve its value.

- Avoid the use of harsh chemicals, such as lacquer thinner, bleach or cleansers containing solvents or abrasives; especially avoid products containing toluene or acetone.
- Avoid bumping or hitting surface with a sharp object, since it could result in a permanent indentation or cut. In the event of abuse, minor surface scratches can sometimes be removed depending on the severity of the damage. The following is recommended:
  - 1) Rub the scratched area with a high grade polishing compound.
  - 2) Polish the area with a caruba based wax.
  - 3) Repair kits are available from paint companies specializing in touch up paints.
- Avoid exposure of doors and drawers to high heat. To ensure against damage to doors or drawers, please do the following:
  - 1) When broiling with oven door open, open doors and drawers of adjacent cabinets to minimize exposure to high heat.
  - 2) Since the door seals on some ranges and ovens allow high heat to escape during the self cleaning cycle, as a precaution, open or remove doors and drawers of adjacent cabinets during the self cleaning cycle. Please read the warranty and instructions for your appliances.
  - 3) Be aware of countertop appliances such as boilers, toasters and toaster ovens that create high heat conditions. They should not be directly under doors of overhead cabinets while in use.

## Drawers fronts

We recommend ordering drawers fronts as doors rather than as reduced rails drawer fronts when they are over 228.6 mm (9") high.

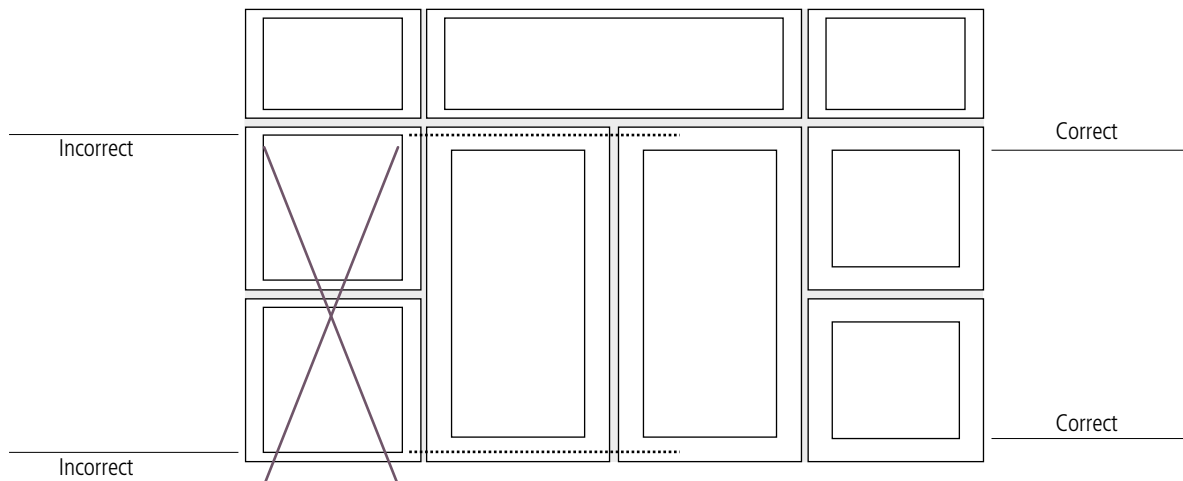

# TECHNICAL SPECIFICATIONS

## Fingerpull

The descriptive codes for fingerpull location have been simplified. (\*) in the new code correspond to the exterior profiles selected. Please replace the asterisk (\*) by the exterior profile letter.

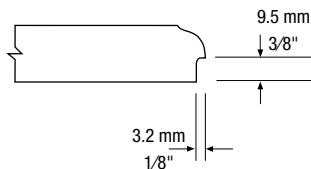

- 1) Can be added to all exterior profiles except **G, H, L, M** and **S**.
- 2) Fingerpulls 4\*\*\*, \*4\*\*, \*\*4\* and \*\*\*4 will be full length – starting 25.4 mm (1") from one side and ending 25.4 mm (1") from the other side.
- 3) All other fingerpulls will be 101.6 mm (4") wide. Fingerpulls on the corners will be 25.4 mm (1") from the end.

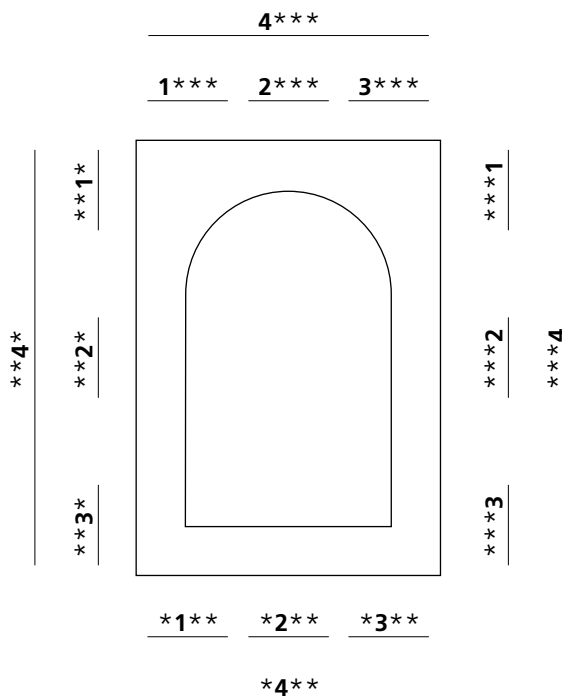

4***	Top full length
*4**	Bottom full length
**4*	Left side full length
***4	Right side full length
1***	Top left
2***	Top centre
3***	Top right
*1**	Bottom left
*2**	Bottom centre
*3**	Bottom right
**1*	Left side top
**2*	Left side centre
**3*	Left side bottom
***1	Right side top
***2	Right side centre
***3	Right side bottom

## Quantity and Location of Hinges

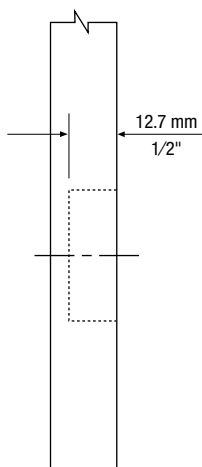
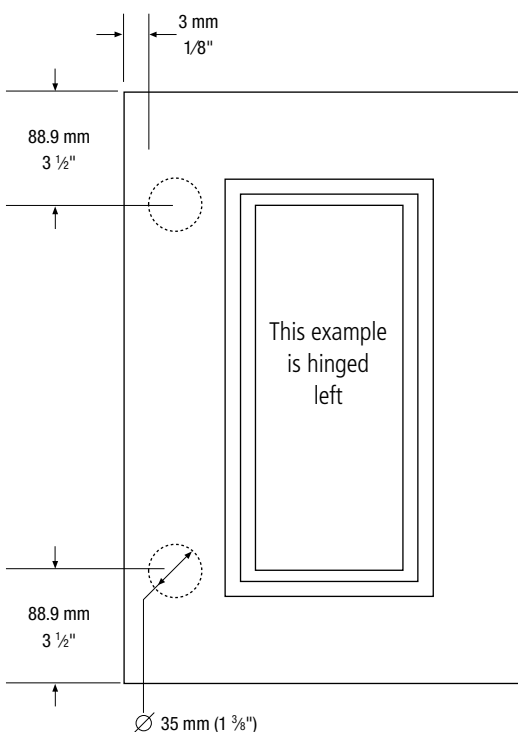

Standard hinge hole diameter: 35 mm (1 3/8")

Standard depth: 12.6 mm (1/2")

Standard location:

- for doors 254 mm (10") and over, 3 mm (1/8") from side and centred at 88.9 mm (3 1/2") from top or bottom edge of the door.
- for doors less than 254 mm (10"), 3 mm (1/8") from side and centred at 63.5 mm (2 1/2") from top or bottom edge of the door.

Note

For doors requiring more than 2 hinges, a drawing indicating actual position of the hinge holes is required.

Door height mm	Door height inches	Number of hinges required
0 to 899.16	0 to 35.4	2
899.17 to 1000.8	35.5 to 39.4	3
1000.9 to 1991.4	39.5 to 78.4	4
1991.5 to 2438.4	78.5 to 96	5

Minimum sizes indicated for each door model must be respected due to hinge clearance considerations.

# COLORS AND FINISHES

Color	Description	Color Group	Color Back	Foil with Peel & Stick	Melamine	HPL	Heatshield fillers	Thermo Edge-banding	PVC Edge-banding
<b>A31S</b>	White - Super Matte	B	White - matte	•	Uniboard 555	Arborite V7001-VR			•
<b>A3WT</b>	Weekend Getaway - Textured	B-C	•	•	Tafisa M2003	T2003-VA Arborite W476-EV	•		•
<b>A4WT</b>	Winter Fun - Textured	B-C	•	•	Tafisa M2004	T2004-VA			•
<b>A15WT</b>	Après-ski - Textured	B-C	•	•	Tafisa M2015	T2015-VA Arborite W490-CW	•		•
<b>A24WT</b>	Dalia ambassador - Textured	B-C	•	•	Uniboard K24	Uniboard K24			•
<b>A54WT</b>	Skye - Textured	B-C	•	•	Uniboard H54	Uniboard H54			•
<b>A60WT</b>	Chiffon - Textured	B-C	•	•	Uniboard K60	Uniboard K60			•
<b>A61WT</b>	Silk - Textured	B-C	•	•	Uniboard K61	Uniboard K61			•
<b>A661S</b>	Moon Light - Satin	B-C	•	•	Tafisa L761	Tafisa T761-KR Formica 912-AN			•
<b>B21R</b>	White - Matte	A	White - matte	•	Arauco W400 Panolam S411 Tafisa L080	Wilsonart D427-60	•	•	•
<b>B44W</b>	Chocolate Pear Tree – Matte	B-C	•	•	Tafisa L444			•	•
<b>B54W</b>	Designer White Woodgrain - Matte	A	White - matte	•				•	
<b>B175R</b>	Snow White - Matte	B	White - matte	•	Uniboard 555 Panolam S557	Formica 949-58*	•		•
<b>B920R</b>	Vogue White - Matte	A	White - matte	•	Arauco W920	Panolam SW888	•	•	•
<b>C35S</b>	White - Satin	D	White - matte	•		Pionite SW826-SD	•	•	•
<b>C72R</b>	Antique White - Matte	A-AA	•	•	Panolam S463 Uniboard 810	Formica 932-58 Wilsonart 1572-60 Arborite S463-CA	• • •	•	•
<b>C72S</b>	Antique White - Satin	D-E	•	•	Panolam S463 Uniboard 810	Wilsonart 1572-07	•	•	
<b>C73R</b>	Frosty White - Matte	A	White - matte	•	Arauco W100	Wilsonart 1573-60*	•	•	•
<b>C92W</b>	Érable naturel - Mat	B-C	•	•	Uniboard 992 Panolam W290	Wilsonart 10776-60 Pionite WM791-SD Nevamar WM5528-SD	• •	•	•
<b>F21W</b>	Candlelight - Matte	B-C	•	•	Tafisa L421 Uniboard 262	Pionite WW6001-SD	•	•	•
<b>F432WT</b>	Taction Oak Alabaster - Textured	B-C	•	•	Arauco WF432	Formica WF432-NG	•		•
<b>F434WT</b>	Taction Oak Gibraltar - Textured	B-C	•	•	Arauco WF434	Formica WF434-NG Pionite WY160-TL	• •		•
<b>F435WT</b>	Taction Oak Palomino - Textured	B-C	•	•	Arauco WF435	Formica WF435-NG Arborite W474-LE	•		•
<b>H109L</b>	Grey HG – High Gloss	F	White - matte	•					•
<b>H110L</b>	Taupe HG – High Gloss	F	White - matte	•					•
<b>K02W</b>	Sesame - Satin	B-C	•	•	Uniboard K02	Uniboard K02 Arborite W2009-AW			•
<b>K16S</b>	White - Super Matte	B	White - matte	•	Arauco W100				•
<b>K75S</b>	Violet Grey - Satin	B	White - matte	•					•
<b>K85S</b>	Mysterious Bleu - Satin	B-C	•	•	Arauco SF247	Panolam FB247			•
<b>K168S</b>	Canadien Grey - Satin	B-C	•	•	Uniboard 168	Uniboard 168 Arborite S406-CA	•		•
<b>K233S</b>	Gountlet Grey - Satin	B-C	•	•	Arauco SF233	Panolam FB233	•		•
<b>K241S</b>	Sienna - Satin	B-C	•	•	Arauco SF230	Panolam FB430	•		•
<b>K257S</b>	Verde - Satin	B-C	•	•	Arauco SF257	Panolam FB257	•		•
<b>K464WT</b>	Urban Nomad - Textured	B-C	•	•	Arauco WF464	Wilsonart 8212K-28 Nevamar WU0030-WE	• •		•
<b>K503S</b>	Celadon Green - Satin	B	•	•	Arauco SF251	Panolam FB251	•		•
<b>K636S</b>	Fjord - Satin	B	White - matte	•					•
<b>K961R</b>	Stainless Steel - Matte	D-E	•	•	Uniboard 961 Panolam A60	Uniboard 961		•	•
<b>P488W</b>	Dolce Vita - Matte	B-C	•	•	Tafisa L488	Tafisa T488-SN			•
<b>P489W</b>	Copa Cabana - Matte	B-C	•	•	Tafisa L489	Tafisa T489-SN Arborite W486-CW	•		•

\* Stock Prémoulé

Shaded Color code indicates same Color back available. All other colors with white back.  
The ultimate responsibility rests solely with the end user with respect to acceptability of these options in specific applications.

# COLORS AND FINISHES

Color	Description	Color Group	Color Back	Foil with Peel & Stick	Melamine	HPL	Heatshield fillers	Thermo Edge-banding	PVC Edge-banding
<b>P492W</b>	White Chocolate - Matte	B-C	•	•	Tafisa L492	Tafisa T492-CR Arborite W478-EV	•		•
<b>P501WT</b>	Linear Ash - Textured	B-C	•	•	Arauco WF368	Formica WF368-WR Arborite W496-CW	• •		•
<b>P909R</b>	Black - Matte	A-AA	Black - matte		Uniboard 888	Formica 909-42 * Arborite S405-CA Wilsonart 1595-60 Pionite SE101-SD	• • • •	•	
<b>R32S</b>	Black - Super Matte	B-C	Black - matte	•	Uniboard 888	Formica 909-58 *	•		•
<b>R42L</b>	Black - High Gloss	F	Black - matte	•		Arborite S405-GL Formica 909-90* Wilsonart 1595-F1	• • •		•
<b>R49L</b>	White - High Gloss	F	White - matte	•		Nevamar S7032-GL Wilsonart 1573-F1*	• •	•	•
<b>R80S</b>	Celestine - Satin	B-C	•	•	Uniboard K80	Uniboard K80			•
<b>R81S</b>	Adobe - Super Matte	B	White - matte	•	Uniboard K81	Uniboard K81			•
<b>R82S</b>	White Smoke - Super Matte	B-C	•	•	Uniboard K82	Uniboard K82 Formica 923-58	•	•	•
<b>R83S</b>	Shipshaw - Super Matte	B-C	•	•	Uniboard K83	Uniboard K83		•	•
<b>R89WT</b>	Cosmos - Textured	B-C	•	•	Uniboard K89	Uniboard K89 Formica 8910-NG	•		•
<b>R105S</b>	White - Super Matte	B	White - matte	•	Tafisa L105	Tafisa T105-CR			•
<b>R205W</b>	Tobacco Cherry - Matte	B-C	•	•	Uniboard 205	Uniboard 205 Pionite HP689-SD Nevamar W8371-T	• •	•	•
<b>R207W</b>	Choco Cherry - Matte	B-C	•	•	Uniboard 207 Tafisa L807	Uniboard 207 Tafisa T807-CR Formica 7739-58 Arborite W415-FP	• •	•	•
<b>R232S</b>	Ashen - Satin	B-C	•	•	Arauco SF232	Formica SF232-58 Panolam FB432 Nevamar S2069-T	• • •		•
<b>R237S</b>	Charcoal - Satin	B	White - matte	•	Arauco SF237	Panolam FB237 Nevamar S6054-T	• •		•
<b>R660S</b>	Rain Cloud - Satin	B-C	•	•	Tafisa L760	Tafisa T760-CR			•
<b>R663S</b>	Morning Dew - Satin	B-C	•	•	Tafisa L763	Tafisa T763-CR Arborite S431-CA Wilsonart 1500-60	• •		•
<b>V66WT</b>	Whisper - Textured	B-C	•	•	Uniboard K66	Uniboard K66 Arborite W485-CW	•		•
<b>V67WT</b>	Rumour - Textured	B-C	•	•	Uniboard K67	Uniboard K67 Wilsonart 8208K-16 Wilsonart 7981K-12 Pionite WA110-SD Nevamar WX0075-AB	• • • •		•
<b>V202S</b>	Summer Drops - Satin	B-C	•	•	Tafisa L202	Tafisa T202-CR			•
<b>V285WT</b>	Jazz Silk - Textured	D	White - matte	•		Wilsonart 1595-18 *	•		•
<b>V393WT</b>	Concrete Groovz - Textured	B-C	•	•	Arauco WF393	Arauco WF393-NG	•		
<b>V629R</b>	Ivory - Matte	A-AA	•	•	Tafisa L204	Tafisa T204-CR		•	•
<b>V731V</b>	Matte Luxe Viridian - Velvet	B	White - matte	•					•
<b>V745V</b>	Matte Luxe Black - Velvet	B	White - matte	•		Nevamar S6053-SM	•		•

\* Stock Prémoulé

# COLORS AND FINISHES



**R54R**  
Designer White - Matte

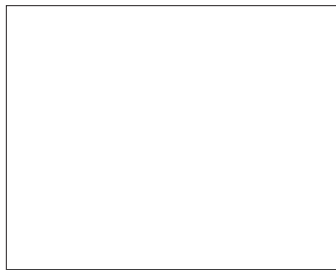

**C35S**  
White - Satin

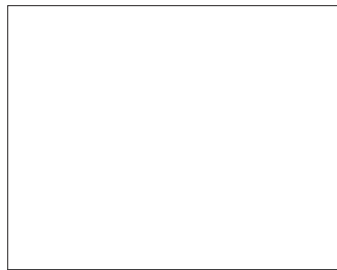

**R105S**  
White - Super Matte

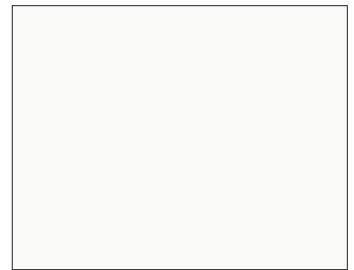

**R49L**  
White - High Gloss

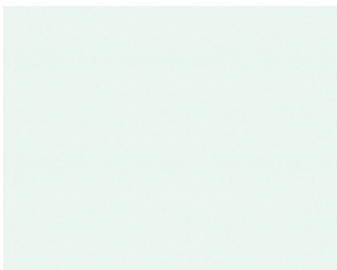

**K16S**  
White - Super Matte

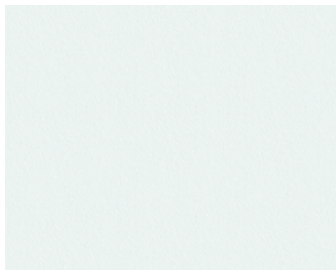

**B175R**  
Snow White - Matte

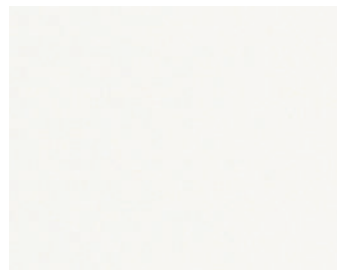

**B21R**  
White - Matte

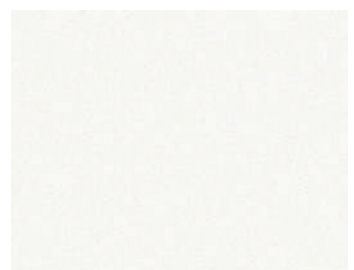

**C73R**  
Frosty White - Matte

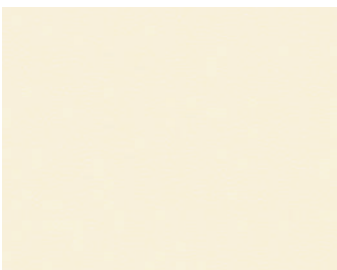

**V629R**  
Ivory - Matte

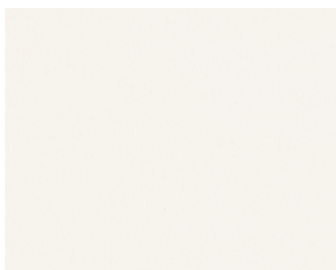

**C72S**  
Antique White - Satin

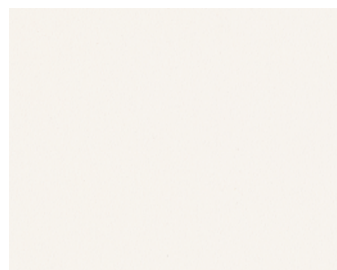

**C72R**  
Antique White - Matte

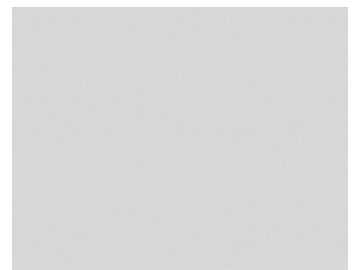

**R82S**  
White Smoke - Super Matte



**R663S**  
Morning Dew - Satin

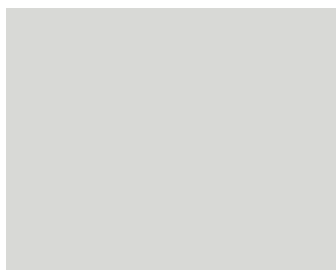

**H109L**  
Gray - High Gloss

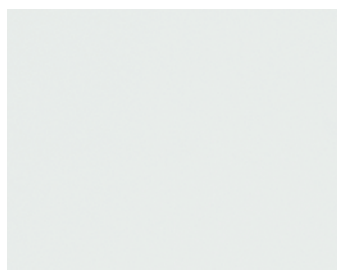

**V202S**  
Summer Drops - Satin



**K168S**  
Canadien Grey - Satin



**R660S**  
Rain Cloud - Satin

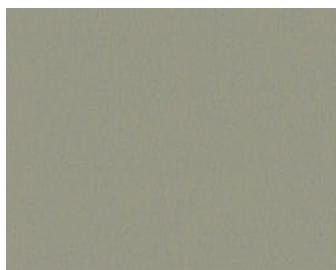

**R232S**  
Ashen - Satin



**K233S**  
Gountlet Grey - Satin



**R83S**  
Shipshaw - Super Matte

# COLORS AND FINISHES

---

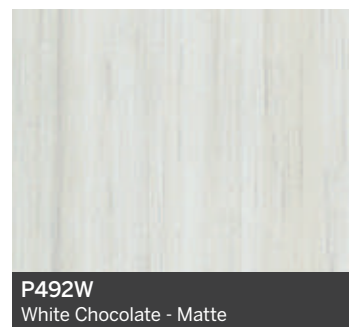
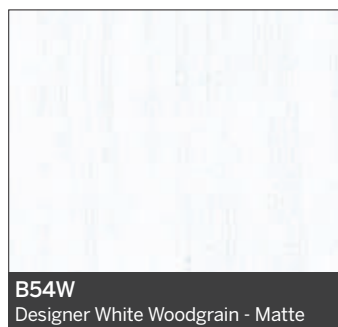
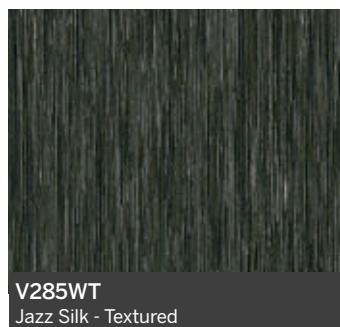
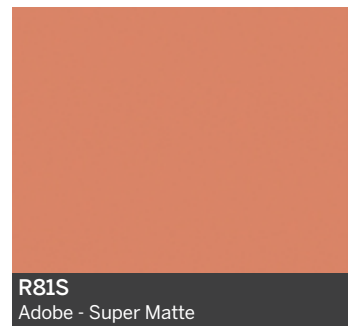
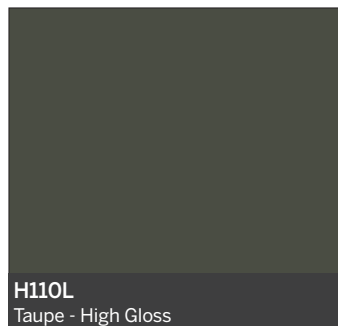
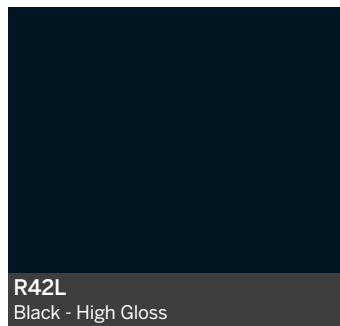
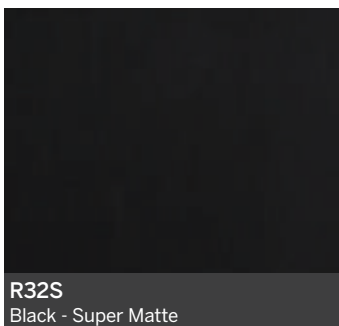
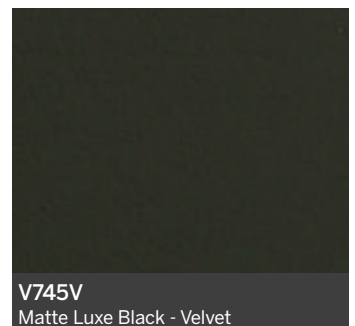
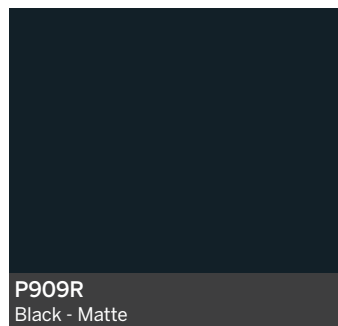
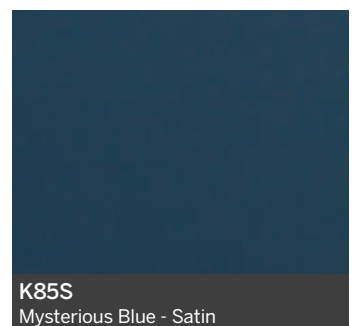
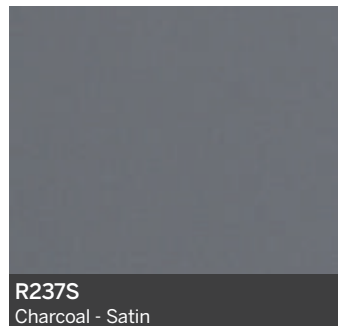
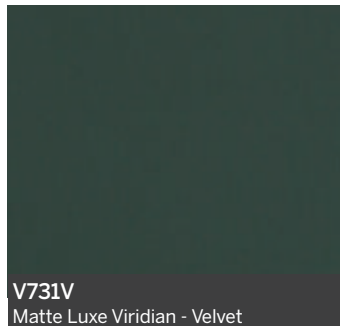
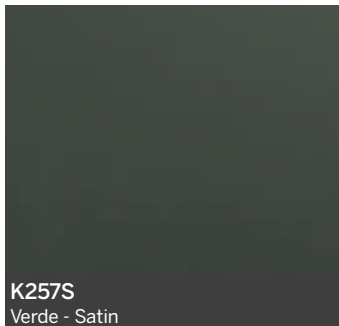
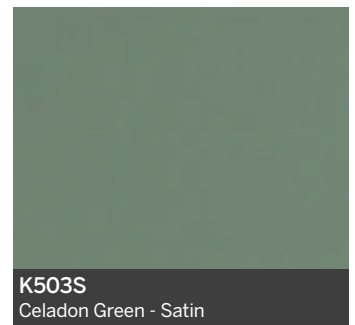
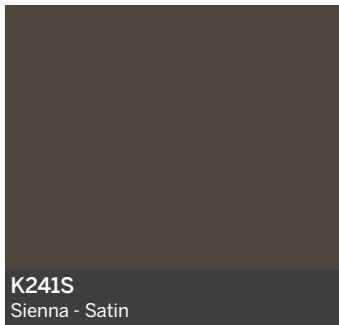

# COLORS AND FINISHES

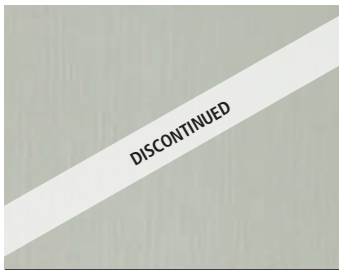

**D530WT**  
Latitude Nord - Textured



**A4WT**  
Winter Fun - Textured



**F432W**  
Taction Oak Alabaster - Satin



**A54WT**  
Skye - Textured



**A3WT**  
Weekend Getaway - Textured



**A61WT**  
Soie - Textured



**V66WT**  
Whisper - Textured



**K464WT**  
Nomade - Textured



**P340W**  
Aria- Matte



**V393WT**  
Concrete Groovz - Textured



**A60WT**  
Mousseline - Textured



**K02W**  
Sesame - Satin

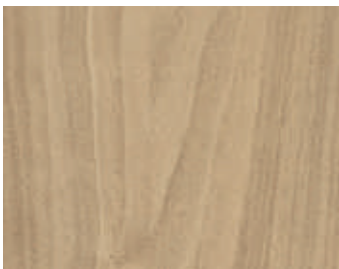

**R89WT**  
Cosmos - Textured



**A15WT**  
Après-ski - Textured



**F435WT**  
Taction Oak Palomino - Textured



**V67WT**  
Rumour - Textured



**C92W**  
Hard Rock Maple - Matte



**F21W**  
Candlelight - Matte



**R205W**  
Tobacco Cherry - Matte

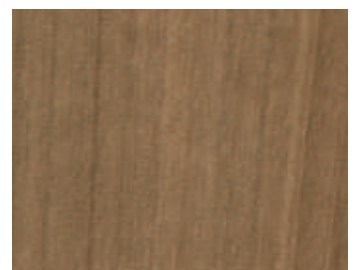

**P488W**  
Dolce Vita - Matte



# COLORS AND FINISHES

---

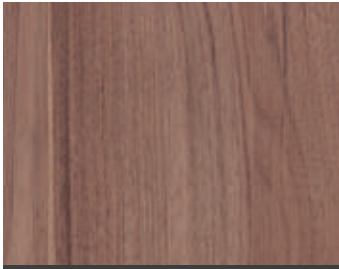

**A24WT**  
Dalia ambassador - Textured

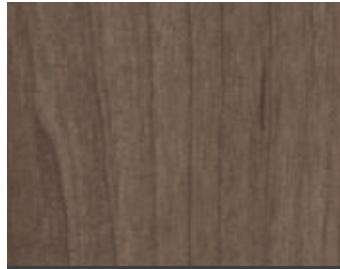

**P489W**  
Copa Cabana - Matte



**F434WT**  
Taction Oak Gibraltar - Textured

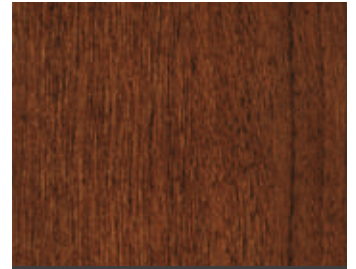

**R207W**  
Choco Cherry - Matte



**R74W**  
Mahogany - Matte



**B44W**  
Chocolate espresso - Woodgrain



**P494W**  
Dark Chocolate - Matte



**R477W-DT**  
Tuxedo - Matte



**V392WT**  
Licorice Groovz - Textured

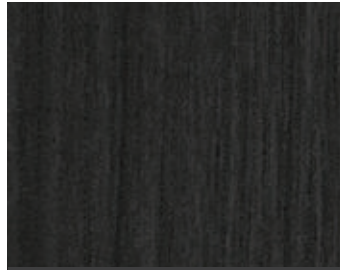

**P501WT**  
Linear Ash - Textured

CERTIFICATE OF  
WARRANTY

10 YEARS

APPLICABLE TO THERMOPLASTIC PRODUCTS  
Starting on January 1<sup>st</sup> 2011 (see conditions on reverse)

Distributor

Invoice #

Date of purchase



# CERTIFICATE OF WARRANTY

## 1. General Terms and Conditions

Prémoulé guarantees its thermoplastic products which are distributed and sold through an authorized distributor.

The installation should only be done by an experienced professional. It is also the responsibility of the person installing the product to determine its suitability for a particular application.

Prémoulé guarantees its products against yellowing, delamination or any apparent or hidden defect that might affect their quality or cause premature deterioration. The following conditions apply:

## 2. Duration

This guarantee is valid for a period of 10 years following the date of purchase.

## 3. Exclusions

This guarantee does not apply:

### 3.1 When damages are caused:

- by misuse or abuse of the product by the buyer
- by improper installation or exposure to the elements
- by any modification, transformation, or correction of the product without a written authorization from Prémoulé;
- by improper storage;
- by any indirect damage (including incidentals, special or consequential damages);
- by exposure to a temperature over 85 °C (185 °F)

### 3.2 To any deterioration of the product resulting from normal wear and tear.

### 3.3 To any damage or incident relating to the costs of installation and transportation, or any other costs relative to the application of this guarantee.

## 4. Scope

This guarantee is unassignable and constitutes the only guarantee offered by Prémoulé.

**There is no guarantee of merchantability or fitness for specific purposes other than the guarantee detailed above. Prémoulé makes no other guarantee whatsoever, expressed or implied, oral or written.**

## 5. Execution of Guarantee

For the duration of this guarantee, in order to exercise his rights, the buyer shall notify as soon as possible the authorized distributor or PRÉMOULÉ of any defect in the product and shall provide proof of purchase or the back of this present certificate properly completed. The buyer shall not make any repairs before the authorized distributor has had an opportunity to examine the product and its installation.

When this guarantee is applicable, Prémoulé may repair its products, provide replacement products or, at its sole option, offer the reimbursement of the purchase price.

## 6. Authorized Distributor

Only an authorized Prémoulé distributor may, in compliance with the terms and conditions of this guarantee, assume the obligations contained herein after obtaining prior authorization from Prémoulé. The authorized distributor is not mandated by Prémoulé to modify or extend the scope of this guarantee.

**Distributed by**

2375, avenue Dalton, bureau 200  
Québec (Québec) Canada G1P 3S3

**T** 418 652-7777 | 1 866 652-7777

**F** 418 652-7558 | 1 866 652-7558

**info@premoule.com**

**premoule.com**

Photography in this leaflet is for illustration purposes only. Actual color may vary slightly due to the printing process. For accurate color selection we recommend that you obtain a product sample.

Prémoulé supports

