



prémoulé



**PORTES
5 MORCEAUX**

**5-PIECE
DOORS**

Collection Avanti

- 2 TENDANCE 45 / 90
- 3 ALLEGRA
- 4 FUSION
- 5 DOLCE
- 6 DELFINO

Collection Mélamine

- 8 SHAKER 90
- 9 NEW SHAKER 90
- 10 PANNEAU UNI / SLAB DOOR

Collection Velour Touch

- 12 TENDANCE 45 / 90
- 13 ALLEGRA - PANNEAU UNI / *SLAB DOOR*
- 14 FUSION- MOULURES ET ACCESSOIRES / *MOULDINGS & ACCESSORIES*
- 15 OFFRE DE COULEURS VELOUR TOUCH / *VELOUR TOUCH COLOR OFFER*

Information complémentaire / *Additional Information*

- 16 PANNEAUX MULTIPLES / *MULTIPLE PANELS*
- 17 VERRIÈRE / *FRAME AND MULLION DOORS*
- 18 MOULURES ET ACCESSOIRES / *MOULDINGS AND ACCESSORIES*
- 19 INSERTIONS DE VERRE / *GLASS INSERTS*
- 20 PENTURES / *HINGES*
- 21 ENTRETIEN / *MAINTENANCE*
- 22 TABLEAU DE CONCORDANCE / *COMPATIBLE COLOR OPTIONS*
- 24 OFFRE DE COULEURS / *COLOR OFFER*

Collection Évolution PurTflex

- 29 SAPHIR
- 30 ONYX 45 / 90
- 31 AZUR
- 32 RUBY
- 33 TABLEAU DE CONCORDANCE / *COMPATIBLE COLOR OPTIONS*
- 34 OFFRE DE COULEURS PURTFLEX / *PURTFLEX COLOR OFFER*
- 36 MOULURES ET ACCESSOIRES / *MOULDINGS AND ACCESSORIES*

Collection Évolution Polyester

- 37 OFFRE DE COULEURS POLYESTER / *POLYESTER COLOR OFFER*
- 38 SHAKER / BORÉAL
- 39 ALLURE / RIVAGE
- 40 POLYESTER – VERRIÈRE / *FRAMED DOOR*
- 41 MOULURES ET ACCESSOIRES / *MOULDINGS AND ACCESSORIES*
- 42 TABLEAU DE CONCORDANCE DES COULEURS / *COMPATIBLE COLOR OPTIONS*
- 44 GARANTIE / *WARRANTY*



AVANTI, TENDANCE 45, BLANC

COLLECTION AVANTI

TENDANCE
ALLEGRA
FUSION
DOLCE
DELFINO

TENDANCE 45 / 90



COULEUR / COLOR: L204

VERRIÈRE /
FRAME DOOR



PANNEAU MULTIPLE /
MULTIPLE PANEL



PLAT / FLAT

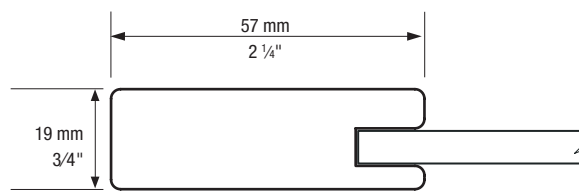

COULEUR / COLOR: WF392

Modèle / Model	Type de modèle / Type of model	Dimensions minimales / Minimum dimensions (Hauteur x Largeur / Height x width)
Tendance 45°	Centre plat et insertions de verre / Flat center panel and glass inserts	5 1/4 x 5 1/4 po / in 133,35 X 133,35 mm
Tendance 90°	Centre plat et insertions de verre / Flat center panel and glass inserts	5 1/4 x 6 1/2 po / in 133,35 X 165,1 mm

Les dimensions maximales des portes sont limitées par les dimensions des feuilles de mélamine soit 4 x 8 pi (1,2 x 2,4 m) ou 5 x 8 pi (1,5 x 2,4 m) selon les couleurs sélectionnées.

Les verrières sont faites pour recevoir une vitre d'une épaisseur de 4 mm.

Formule pour le calcul du verre requis pour la verrière, voir p. 13.

Portes assemblées 45° / 90° de plus de 42 po :

- sans traverse centrale : la garantie contre le gauchissement ne sera pas applicable
- avec traverse centrale : la garantie contre le gauchissement sera applicable. /

Maximum door dimensions are limited by melamine sheet dimensions, either 4 x 8 ft (1,2 x 2,4 m) or 5 x 8 ft (1,5 x 2,4 m) for selected colors.

The frame doors are made to fit a 4 mm thick glass.

Formula to calculate size of the glass for frame and mullion doors, see p. 13.

Doors with 45° / 90° degree assembly over 42 in :

- *Without middle cross-rail: will not carry any guarantee against warpage.*
- *With a middle crosspiece: will be guaranteed against warpage.*



COULEUR / COLOR: L105



VERRIÈRE / FRAME DOOR

VERRIÈRE CARREAUX /
MULTIPLE MULLION

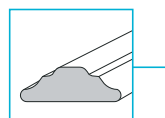

PLAT / FLAT

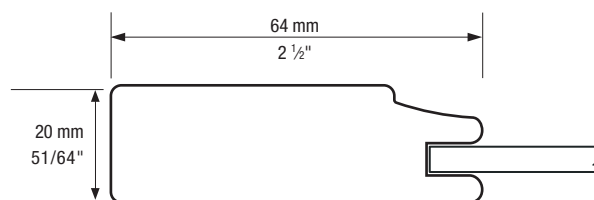

Type de modèle / Type of model	Dimensions minimales / Minimum dimensions (Hauteur x Largeur / Height x width)
Centre plat et insertions de verre / Flat center panel and glass inserts	5 3/4 x 5 3/4 po / in 146.05 X 146.05 mm
Verrière carreaux / Multiple mullion	11 x 11 po / in 279,5 X 279,4 mm

Les dimensions maximales des portes sont limitées par les dimensions des feuilles de mélamine soit 4 x 8 pi (1,2 x 2,4 m) ou 5 x 8 pi (1,5 x 2,4 m) selon les couleurs sélectionnées.

Les verrières sont faites pour recevoir une vitre d'une épaisseur de 4 mm.

Formule pour le calcul du verre requis pour la verrière, voir p. 13. /

Maximum door dimensions are limited by melamine sheet dimensions, either 4 x 8 ft (1,2 x 2,4 m) or 5 x 8 ft (1,5 x 2,4 m) for selected colors.

The frame doors are made to fit a 4 mm thick glass.

Formula to calculate size of the glass for frame and mullion doors, see p. 13.

FUSION



COULEUR / COLOR: L-530



VERRIÈRE / FRAME DOOR



PANNEAU MULTIPLE / MULTIPLE PANEL



PLAT / FLAT

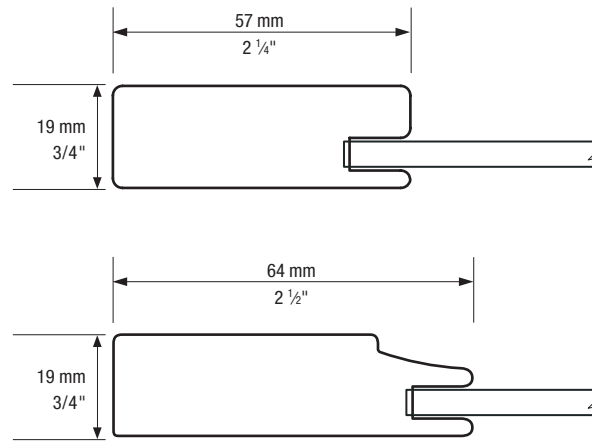

Type de modèle / Type of model	Dimensions minimales / Minimum dimensions (Hauteur x Largeur / Height x width)
Centre plat et insertions de verre / Flat center panel and glass inserts	5 3/4 x 6 1/2 po / in 146,05 X 165,1 mm

Les dimensions maximales des portes sont limitées par les dimensions des feuilles de mélamine soit 4 x 8 pi (1,2 x 2,4 m) ou 5 x 8 pi (1,5 x 2,4 m) selon les couleurs sélectionnées.

Les verrières sont faites pour recevoir une vitre d'une épaisseur de 4 mm.

Formule pour le calcul du verre requis pour la verrière, voir p. 13.

Portes assemblées 45° / 90° de plus de 42 po :

- sans traverse centrale : la garantie contre le gauchissement ne sera pas applicable
- avec traverse centrale : la garantie contre le gauchissement sera applicable. /

Maximum door dimensions are limited by melamine sheet dimensions, either 4 x 8 ft (1,2 x 2,4 m) or 5 x 8 ft (1,5 x 2,4 m) for selected colors.

The frame doors are made to fit a 4 mm thick glass.

Formula to calculate size of the glass for frame and mullion doors, see p. 13.

Doors with 45° / 90° degree assembly over 42 in :

- *Without middle cross-rail: will not carry any guarantee against warpage.*
- *With a middle crosspiece: will be guaranteed against warpage.*



COULEUR / COLOR: H-54

VERRIÈRE / FRAME DOOR



PLAT / FLAT

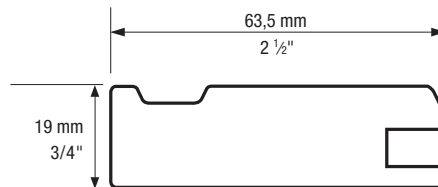

Type de modèle / Type of model	Dimensions minimales / Minimum dimensions (Hauteur x Largeur / Height x width)
Centre plat et insertions de verre / Flat center panel and glass inserts	5 ⁵¹ / ₆₄ x 5 ⁵¹ / ₆₄ po / in 147,24 X 147,24 mm

Les dimensions maximales des portes sont limitées par les dimensions des feuilles de mélamine soit 4 x 8 pi (1,2 x 2,4 m) ou 5 x 8 pi (1,5 x 2,4 m) selon les couleurs sélectionnées.

Les verrières sont faites pour recevoir une vitre d'une épaisseur de 4 mm.

Formule pour le calcul du verre requis pour la verrière, voir p. 13. /

Maximum door dimensions are limited by melamine sheet dimensions, either 4 x 8 ft (1,2 x 2,4 m) or 5 x 8 ft (1,5 x 2,4 m) for selected colors.

The frame doors are made to fit a 4 mm thick glass.

Formula to calculate size of the glass for frame and mullion doors, see p. 13.

DELFINO



COULEUR / COLOR: T444

VERRIÈRE / FRAME DOOR



VERRIÈRE CARREAUX / MULTIPLE MULLION

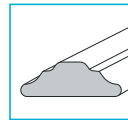

PLAT / FLAT

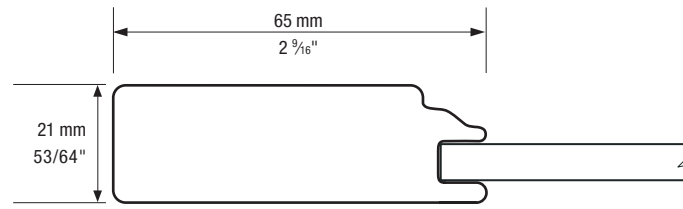

Type de modèle / Type of model	Dimensions minimales / Minimum dimensions (Hauteur x Largeur / Height x width)
Centre plat et insertions de verre / Flat center panel and glass inserts	5 ²⁹ / ₃₂ x 5 ²⁹ / ₃₂ po / in 150,02 X 150,02 mm
Verrière carreaux / Multiple mullion	11 ⁵ / ₃₂ x 11 ⁵ / ₃₂ po / in 283,37 X 283,37 mm

Les dimensions maximales des portes sont limitées par les dimensions des feuilles de mélamine soit 4 x 8 pi (1,2 x 2,4 m) ou 5 x 8 pi (1,5 x 2,4 m) selon les couleurs sélectionnées.

Les verrières sont faites pour recevoir une vitre d'une épaisseur de 4 mm.

Formule pour le calcul du verre requis pour la verrière, voir p. 13. /

Maximum door dimensions are limited by melamine sheet dimensions, either 4 x 8 ft (1,2 x 2,4 m) or 5 x 8 ft (1,5 x 2,4 m) for selected colors.

The frame doors are made to fit a 4 mm thick glass.

Formula to calculate size of the glass for frame and mullion doors, see p. 13.



MELAMINE, PANNEAU UNI, K64

Crédit photo: Uniboard®

COLLECTION MÉLAMINE

SHAKER 90
NEW SHAKER 90
PANNEAU UNI /
SLAB DOOR

SHAKER 90



COULEUR / COLOR: K62



PLAT / FLAT

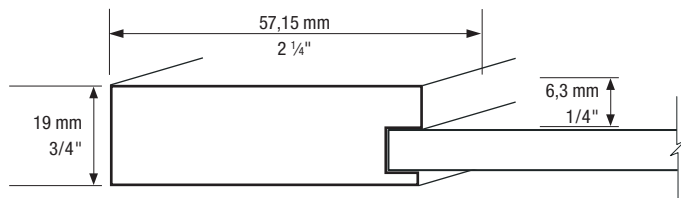

Type de modèle / Type of model	Dimensions minimales / Minimum dimensions (Hauteur x Largeur / Height x width)
Centre plat / Flat center panel	5 1/4 x 6 1/2 po / in 133,35 X 165,1 mm
Verrière / Frame door	6 25/64 x 7 41/64 po / in 162,32 X 194,07 mm

Les dimensions maximales des portes sont limitées par les dimensions des feuilles de mélamine soit 4 x 8 pi (1,2 x 2,4 m) ou 5 x 8 pi (1,5 x 2,4 m) selon les couleurs sélectionnées.

Les verrières sont faites pour recevoir une vitre d'une épaisseur de 4 mm.

Formule pour le calcul du verre requis pour la verrière, voir p. 13.

Portes assemblées 45° / 90° de plus de 42 po :

- sans traverse centrale : la garantie contre le gauchissement ne sera pas applicable
- avec traverse centrale : la garantie contre le gauchissement sera applicable. /

Maximum door dimensions are limited by melamine sheet dimensions, either 4 x 8 ft (1,2 x 2,4 m) or 5 x 8 ft (1,5 x 2,4 m) for selected colors.

The frame doors are made to fit a 4 mm thick glass.

Formula to calculate size of the glass for frame and mullion doors, see p. 13.

Doors with 45° / 90° degree assembly over 42 in :

- Without middle cross-rail: will not carry any guarantee against warpage.
- With a middle crosspiece: will be guaranteed against warpage.

NEW SHAKER 90



VERRIÈRE /
FRAME DOOR



VERRIÈRE CARREAUX /
MULTIPLE MULLION

PANNEAU MULTIPLE /
MULTIPLE PANEL



69,85 mm
2 3/4"

COULEUR / COLOR: M-2003



PLAT / FLAT

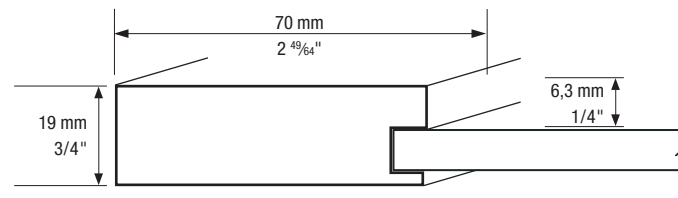

Type de modèle / Type of model	Dimensions minimales / Minimum dimensions (Hauteur x Largeur / Height x width)	
	Portes / Doors	Tiroirs / Drawer fronts
Centre plat / Flat center panel	7 x 8 1/2 po / in 177,8 X 215,9 mm	5 1/4 x 8 1/2 po / in 133,35 X 215,9 mm
Verrière / Frame door	8 1/2 x 8 1/2 po / in 215,9 X 215,9 mm	

Tiroirs : battants largeurs réduits 57,15 mm (2 1/4 po) pour le New Shaker 90°.

Si des battants non réduits sont désirés, prendre porte en commande avec sa dimension minimale.

Les dimensions maximales des portes sont limitées par les dimensions des feuilles de mélamine soit 4 x 8 pi (1,2 x 2,4 m) ou 5 x 8 pi (1,5 x 2,4 m) selon les couleurs sélectionnées.

Les verrières sont faites pour recevoir une vitre d'une épaisseur de 4 mm.

Formule pour le calcul du verre requis pour la verrière, voir p. 13.

Portes assemblées 45° / 90° de plus de 42 po :

- sans traverse centrale : la garantie contre le gauchissement ne sera pas applicable
- avec traverse centrale : la garantie contre le gauchissement sera applicable. /

Drawer fronts: reduced rails 57,15 mm (2 1/4 in) for New Shaker 90°.

If non-reduced rails are desired, please order as a door and its respective minimum size

Maximum door dimensions are limited by melamine sheet dimensions, either 4 x 8 ft (1,2 x 2,4 m) or 5 x 8 ft (1,5 x 2,4 m) for selected colors.

The frame doors are made to fit a 4 mm thick glass.

Formula to calculate size of the glass for frame and mullion doors, see p. 13.

Doors with 45° / 90° degree assembly over 42 in :

- Without middle cross-rail: will not carry any guarantee against warpage.
- With a middle crosspiece: will be guaranteed against warpage.

PANNEAU UNI / SLAB DOOR



COULEUR / COLOR: H-53



PLAT / FLAT

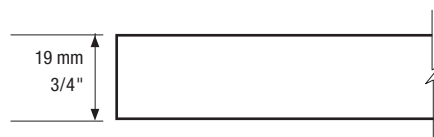

Type de modèle / Type of model	Dimensions minimales / Minimum dimensions (Hauteur x Largeur / Height x width)
Centre plat / Flat center panel	6 x 2 1/4 po / in 152,4 X 57 mm

Le grain de bois standard du Panneau uni est à la verticale, grain de bois à l'horizontale disponible sur demande.

Les dimensions maximales des portes sont limitées par les dimensions des feuilles de mélamine soit 4 x 8 pi (1,2 x 2,4 m) ou 5 x 8 pi (1,5 x 2,4 m) selon les couleurs sélectionnées. /

Standard vertical grain for Slab Door, horizontal grain available on request.

Maximum door dimensions are limited by melamine sheet dimensions, either 4 x 8 ft (1,2 x 2,4 m) or 5 x 8 ft (1,5 x 2,4 m) for selected colors.



VELOUR TOUCH, PANNEAU UNI, VT25

COLLECTION VELOUR TOUCH

TENDANCE 90 / 45

ALLEGRA

PANNEAU UNI /
SLAB DOOR

FUSION

TENDANCE 90 / 45



COULEUR / COLOR: VT26



PANNEAU MULTIPLE / MULTIPLE PANEL



VERRIÈRE / FRAME DOOR



PLAT / FLAT

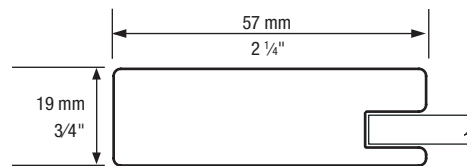

COULEUR / COLOR: VT06



PLAT / FLAT

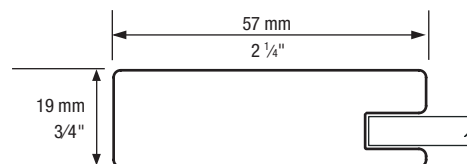

Les dimensions maximales des portes sont limitées par les dimensions des feuilles de mélamine soit 4 x 8 pi (1,2 x 2,4 m) ou 5 x 8 pi (1,5 x 2,4 m) selon les couleurs sélectionnées.

Les verrières sont faites pour recevoir une vitre d'une épaisseur de 4 mm. Formule pour le calcul du verre requis pour la verrière, voir p. 13 de notre brochure Portes 5 morceaux..

Portes assemblées 45° / 90° de plus de 42 po :

- sans traverse centrale: la garantie contre le gauchissement ne sera pas applicable
- avec traverse centrale: la garantie contre le gauchissement sera applicable. /

Maximum door dimensions are limited by melamine sheet dimensions, either 4 x 8 ft (1,2 x 2,4 m) or 5 x 8 ft (1,5 x 2,4 m) for selected colors.

The frame doors are made to fit a 4 mm thick glass. Formula to calculate size of the glass for frame and mullion doors, see p. 13 of our brochure 5 pieces Doors.

Doors with 45° / 90° degree assembly over 42 in :

- Without middle cross-rail: will not carry any guarantee against warpage.
- With a middle crosspiece: will be guaranteed against warpage.

Modèle / Model	Type de modèle / Type of model	Dimensions minimales / Minimum dimensions (Hauteur x Largeur / Height x width)
Tendance 45°	Centre plat / Flat center panel	5 1/4 x 5 1/4 po / in 133,35 X 133,35 mm
Tendance 90°	Centre plat / Flat center panel	5 1/4 x 6 1/2 po / in 133,35 X 165,1 mm



COULEUR / COLOR: VT25

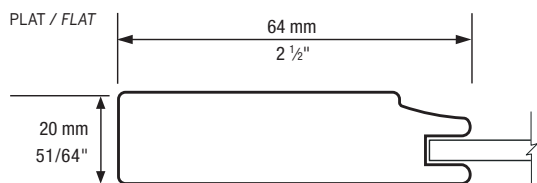

VERRIÈRE /
FRAME DOOR



Type de modèle / Type of model	Dimensions minimales / Minimum dimensions (Hauteur x Largeur / Height x width)
Centre plat / Flat center panel	5 3/4 x 5 3/4 po / in – 146,05 X 146,05 mm
Verrière / Frame Door	11 x 11 po / in – 279,5 X 279,4 mm

Les verrières sont faites pour recevoir une vitre d'une épaisseur de 4 mm.

Formule pour le calcul du verre requis pour la verrière, voir p. 13 de notre brochure Portes 5 morceaux. /
The frame doors are made to fit a 4 mm thick glass.

Formula to calculate size of the glass for frame and mullion doors, see p. 13 of our brochure 5 pieces Doors.

Les dimensions maximales des portes sont limitées par les dimensions des feuilles de mélamine soit 4 x 8 pi (1,2 x 2,4 m) ou 5 x 8 pi (1,5 x 2,4 m) selon les couleurs sélectionnées.

Maximum door dimensions are limited by melamine sheet dimensions, either 4 x 8 ft (1,2 x 2,4 m) or 5 x 8 ft (1,5 x 2,4 m) for selected colors.

PANNEAU UNI / SLAB DOOR

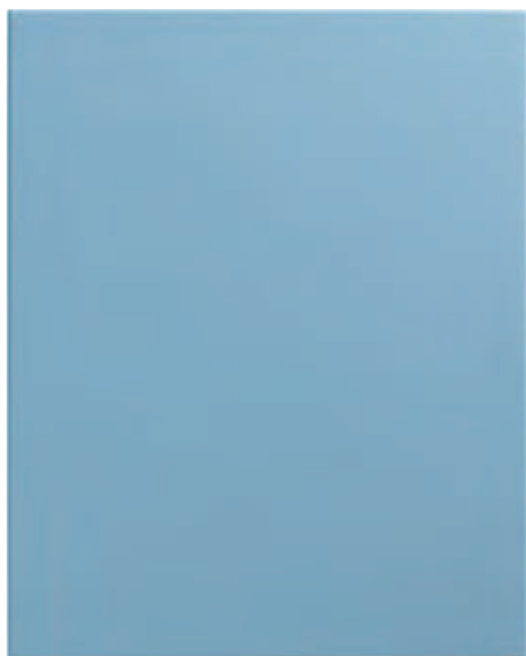

COULEUR / COLOR: VT25



PLAT / FLAT

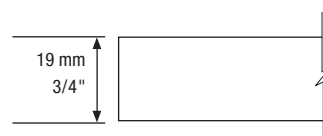

Type de modèle / Type of model	Dimensions minimales / Minimum dimensions (Hauteur x Largeur / Height x width)
Centre plat / Flat center panel	6 x 2 1/4 po / in 152,4 X 57 mm

FUSION



COULEUR / COLOR: VT24



VERRIÈRE /
FRAME DOOR



PLAT / FLAT

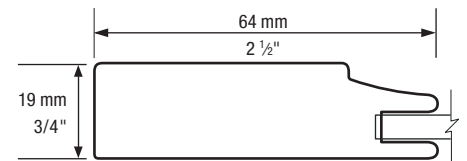
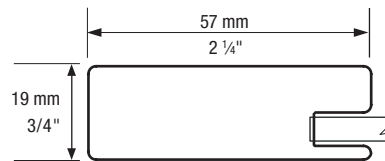

Modèle / Model	Type de modèle / Type of model	Dimensions minimales / Minimum dimensions (Hauteur x Largeur / Height x width)
Fusion	Centre plat / Flat center panel	5 3/4 x 6 1/2 po / in 146,05 X 165,1 mm

Les dimensions maximales des portes sont limitées par les dimensions des feuilles de mélamine soit 4 x 8 pi (1,2 x 2,4 m) ou 5 x 8 pi (1,5 x 2,4 m) selon les couleurs sélectionnées.

Les verrières sont faites pour recevoir une vitre d'une épaisseur de 4 mm. Formule pour le calcul du verre requis pour la verrière, voir p. 13 de notre brochure Portes 5 morceaux..

Portes assemblées 45° / 90° de plus de 42 po :

- sans traverse centrale : la garantie contre le gauchissement ne sera pas applicable
- avec traverse centrale : la garantie contre le gauchissement sera applicable. /

Maximum door dimensions are limited by melamine sheet dimensions, either 4 x 8 ft (1,2 x 2,4 m) or 5 x 8 ft (1,5 x 2,4 m) for selected colors.

The frame doors are made to fit a 4 mm thick glass. Formula to calculate size of the glass for frame and mullion doors, see p. 13 of our brochure 5 pieces Doors.

Doors with 45° / 90° degree assembly over 42 in :

- Without middle cross-rail: will not carry any guarantee against warpage.
- With a middle crosspiece: will be guaranteed against warpage.

Moulures et accessoires disponibles / Mouldings & accessories available

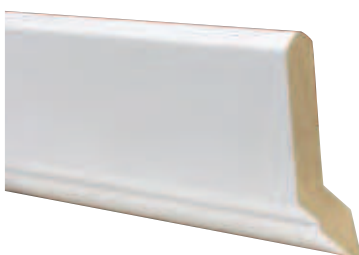

ML4716

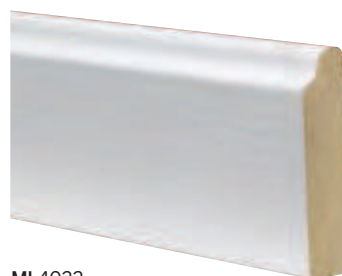

ML4022

Offre de couleurs Velour Touch / *Velour Touch Color Offer*

OLON 



#	Couleurs / Colors	Fini / Finish	Fournisseur / Supplier	Cat							
					Tendance 45	Tendance 90	Delfino	Allegra	Fusion	Dolce	Panneau uni / Slab door
VT00	Pierre de suède / <i>Suede Stone</i>	Velour Touch	Olon	V	P	P		P	P		P
VT01	Crépuscule de cachemire / <i>Cashmere Dusk</i>	Velour Touch APEX	Olon	W	P	P		P	P		P
VT02	Blan coton / <i>Cotton Mist</i>	Velour Touch APEX	Olon	V	P	P		P	P		P
VT03	Velours Noir / <i>Black</i>	Velour Touch APEX	Olon	W	P	P		P	P		P
VT06	Gris oxford / <i>Oxford Grey</i>	Velour Touch	Olon	V	P	P		P	P		P
VT08	Chaleur d'alpaga / <i>Warm Alpaga</i>	Velour Touch	Olon	V	P	P		P	P		P
VT10	Fraîcheur de lin / <i>Fresh Linen</i>	Velour Touch APEX	Olon	V	P	P		P	P		P
VT11	Bleu merino / <i>Merino Blue</i>	Velour Touch APEX	Olon	V	P	P		P	P		P
VT13	Forêt luxuriante / <i>Plush Forest</i>	Velour Touch APEX	Olon	V	P	P		P	P		P
VT24	Brouillard de jersey / <i>Jersey Fog</i>	Velour Touch	Olon	V	P	P		P	P		P
VT25	Chiffon bleu / <i>Blue Chiffon</i>	Velour Touch	Olon	V	P	P		P	P		P
VT26	Tiges de bambou / <i>Bamboo Shoots</i>	Velour Touch	Olon	V	P	P		P	P		P

Informez-vous auprès du service à la clientèle pour connaître le distributeur autorisé de votre région. /
Contact customer service for information on your local authorized distributor.

PANNEAUX MULTIPLES / MULTIPLE PANELS

DIMENSIONS MINIMUM / MINIMUM DIMENSIONS

MODÈLE DOUBLE HORIZONTAL / DOUBLE HORIZONTAL MODEL

MODÈLE / MODEL	HAUTEUR / HEIGHT	LARGEUR / WIDTH	MESURE A / MEASURE A
Shaker 90°	7 ⁷ / ₈ po / in 200 mm	6 ¹ / ₂ po / in 165,1 mm	3 ¹⁵ / ₁₆ po / in 100 mm
New Shaker 90°	9 ⁴⁹ / ₆₄ po / in 248 mm	8 ¹ / ₂ po / in 215,9 mm	4 ⁵⁷ / ₆₄ po / in 124 mm
Tendance 45° / 90°	8 ⁹ / ₃₂ po / in 210 mm	6 ¹ / ₂ po / in 165,1 mm	4 ⁹ / ₆₄ po / in 105 mm
Fusion	8 ²⁵ / ₃₂ po / in 223 mm	6 ¹ / ₂ po / in 165,1 mm	4 ³ / ₈ po / in 111 mm

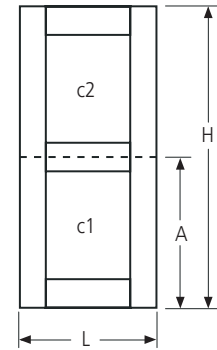

MODÈLE DOUBLE VERTICAL / DOUBLE VERTICAL MODEL

MODÈLE / MODEL	HAUTEUR / HEIGHT	LARGEUR / WIDTH	MESURE A / MEASURE A
Shaker 90°	5 po / in 127 mm	7 ⁷ / ₈ po / in 200 mm	3 ¹⁵ / ₁₆ po / in 100 mm
New Shaker 90°	6 ¹⁷ / ₆₄ po / in 159 mm	9 ⁴⁹ / ₆₄ po / in 248 mm	4 ⁵⁷ / ₆₄ po / in 124 mm
Tendance 45° / 90°	6 po / in 152 mm	8 ⁹ / ₃₂ po / in 210 mm	4 ⁹ / ₆₄ po / in 105 mm

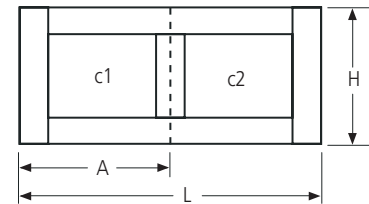

MODÈLE TRIPLE HORIZONTAL / TRIPLE HORIZONTAL MODEL

MODÈLE / MODEL	HAUTEUR / HEIGHT	LARGEUR / WIDTH	MESURE A / MEASURE A	MESURE B / MEASURE B
Shaker 90°	10 ³ / ₄ po / in 273 mm	6 ¹ / ₂ po / in 165,1 mm	3 ¹⁵ / ₁₆ po / in 100 mm	6 ¹³ / ₁₆ po / in 173 mm
New Shaker 90°	13 ⁹ / ₃₂ po / in 337 mm	8 ¹ / ₂ po / in 215,9 mm	4 ⁵⁷ / ₆₄ po / in 124 mm	8 ²⁵ / ₆₄ po / in 213 mm
Tendance 45° / 90°	11 ¹⁷ / ₆₄ po / in 286 mm	6 ¹ / ₂ po / in 165,1 mm	4 ⁹ / ₆₄ po / in 105 mm	7 ⁹ / ₆₄ po / in 181 mm
Fusion	11 ⁴⁷ / ₆₄ po / in 298 mm	6 ¹ / ₂ po / in 165,1 mm	4 ³ / ₈ po / in 111 mm	7 ⁹ / ₆₄ po / in 181 mm

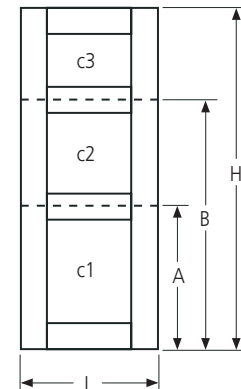

MODÈLE TRIPLE VERTICAL / TRIPLE VERTICAL MODEL

MODÈLE / MODEL	HAUTEUR / HEIGHT	LARGEUR / WIDTH	MESURE A / MEASURE A	MESURE B / MEASURE B
Shaker 90°	5 po / in 127 mm	10 ³ / ₄ po / in 273 mm	3 ¹⁵ / ₁₆ po / in 100 mm	6 ¹³ / ₁₆ po / in 173 mm
New Shaker 90°	6 ¹⁷ / ₆₄ po / in 159 mm	13 ⁹ / ₃₂ po / in 337 mm	4 ⁵⁷ / ₆₄ po / in 124 mm	8 ²⁵ / ₆₄ po / in 213 mm
Tendance 45° / 90°	6 po / in 152 mm	11 ¹⁷ / ₆₄ po / in 286 mm	4 ⁹ / ₆₄ po / in 105 mm	7 ⁹ / ₆₄ po / in 181 mm

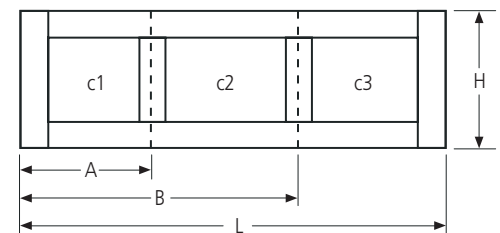

Non disponible dans le modèle Shaker 90. /

Not available with the Shaker 90 model.

VERRIÈRES / FRAME AND MULLION DOORS



4 CARREAUX / 4 LITES

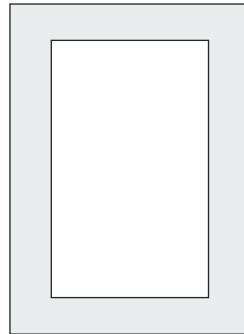

STANDARD / 1 LITE

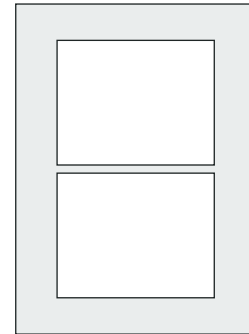

2 CARREAUX / 2 LITES

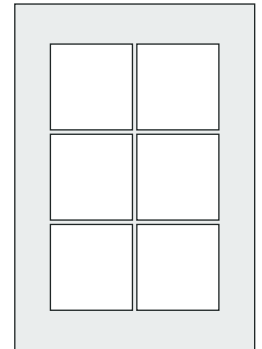

6 CARREAUX / 6 LITES

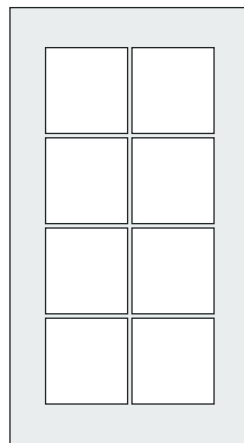

8 CARREAUX / 8 LITES

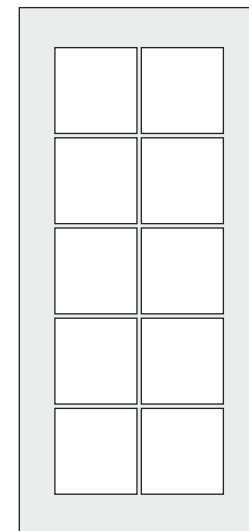

10 CARREAUX / 10 LITES

MOULURE À VITRE /
GLASS RETAINER
MOULDING

Transparent / Clear

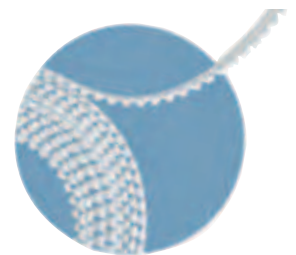

Type de modèle / Type of model	Mesures pour insertions de verre / Sizes for glass inserts (Hauteur x Largeur / Height x width)
Tendance 45	3 7/8 x 3 7/8 po / in 98,4 X 98,4 mm
Tendance 90	3 1/2 x 3 13/16 po / in 88,9 X 96,84 mm
Allegra	4 3/8 x 4 3/8 po / in 111,1 X 111,1 mm
Fusion	4 x 3 13/16 po / in 101,6 X 96,84 mm
Delfino	4 1/2 x 4 1/2 po / in 114,3 X 114,3 mm
Fascination	3 7/8 x 3 7/8 po / in 98,4 X 98,4 mm
Shaker 90	3 3/4 x 3 13/16 po / in 95,25 X 96,84 mm
New Shaker 90	4 11/16 x 4 13/16 po / in 119,06 X 122,24 mm
Dolce	4 3/8 x 4 3/8 po / in 111,1 X 111,1 mm

INSTALLATION DE LA VITRE / GLASS INSTALLATION

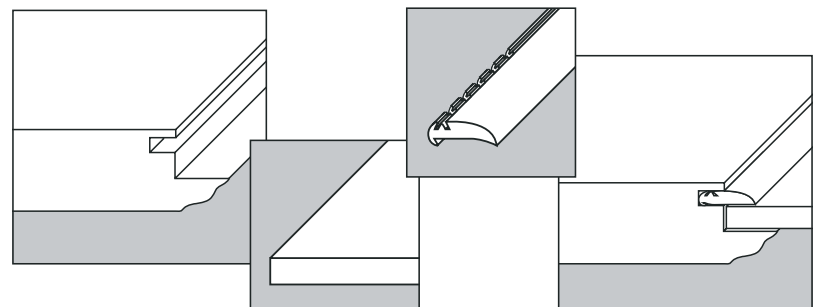

Moules et accessoires / Mouldings & accessories



4022
Cache-néon / *Light valence*
Longueur / *Length* : 9 pi / ft

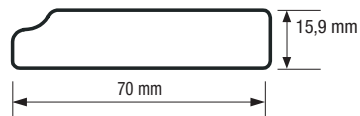

4766
Ogee concave / *Concave Ogee*
Longueur / *Length* : 9 pi / ft

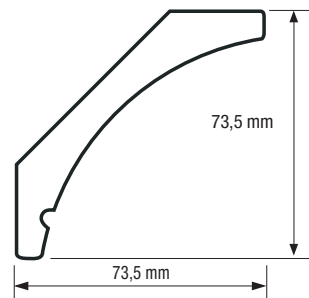

5027
Ogee régulier / *Regular Ogee*
Longueur / *Length* : 9 pi / ft

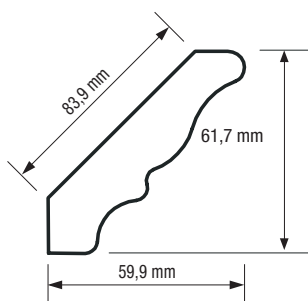

WP22
Moulure de tête contemporaine / *Contemporary crown moulding*
Longueur / *Length* : 9 pi / ft

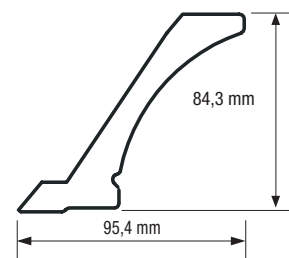

Maintenant disponible dans toutes les couleurs des nuanciers des collections Avanti et Mélamine. /
Now available in all Avanti and Melamine collection colors.

FEUILLES DE MÉLAMINE / MELAMINE SHEETS

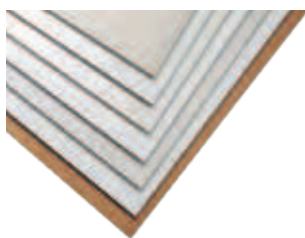

Grandeurs disponibles / *Sizes available*

- 1,2 x 2,4 m (4 x 8 pi / ft)
- 1,5 x 2,4 m (5 x 8 pi / ft)

Épaisseur / *Thickness* :

- 6,4 mm (1/4 po / in) Toutes les couleurs / *All colors*
- 19 mm (3/4 po / in) Couleurs mélamine seulement / *Melamine colors only*

BANDES DE CHANT EN PVC / PVC EDGE BANDING



Grandeurs disponibles / *Sizes available*

- Épaisseur / *Thickness* : 0,5 mm (1/64 po / in)
Rouleau / *Roll* : 600 pi / ft (182,8 m)
Largeur / *Width* : 7/8 po / in
- Épaisseur / *Thickness* : 1 mm (3/64 po / in)
Rouleau / *Roll* : 300 pi / ft (91,4 m)
Largeur / *Width* : 7/8 po / in

Insertions de verre / Glass Inserts



CLAIR / CLEAR



SATIN / FROSTED



MIROIR / MIRROR



FLUTEX

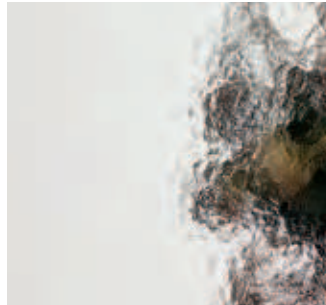

CATHÉDRALE / CATHEDRAL



CHINCHILLA



GOTHIQUE / GOTHIC

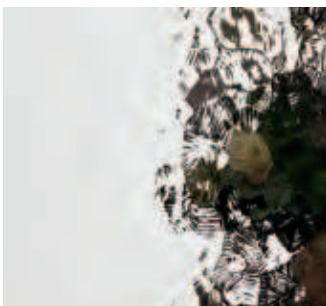

OCÉANIQUE / OCEANIC

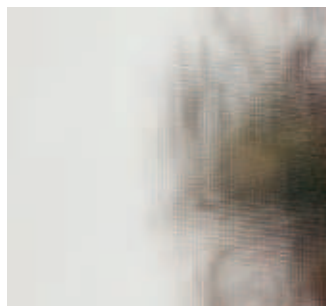

ÉCRAN / SCREEN



MASTERCARRÉ



BAMBOO

Assemblée en usine et ne requiert aucune moulure de verre.

SPÉCIFICATIONS

- Verre trempé minimum 4 mm*.
- Sur mesure, détails à déterminer selon vos besoins.
- Standard 1 porte.
- Minimum-maximum tel que nos portes.
- Disponible dans tous les modèles polyester seulement.

* Sauf le miroir, 3 mm non trempé./

Factory assembled and does not require glass retainer.

SPECIFICATIONS

- *Minimum 4 mm tempered glass*.*
- *This product is custom made, details are to be determined according to your needs.*
- *Standard 1 door.*
- *The min/max such as our doors.*
- *Available in our polyester models only.*

** Except Mirror, 3 mm non-tempered.*

Disponible pour les collections Avanti et Évolution.
Non disponible dans la collection Velour Touch et dans le modèle Shaker 90. /
Available for Avanti and Evolution collections.
Not available with the Velour Touch collection and the Shaker 90 model.

Pentures / Hinges

NORMES POUR LES PENTURES / QUANTITY AND LOCATION OF HINGES

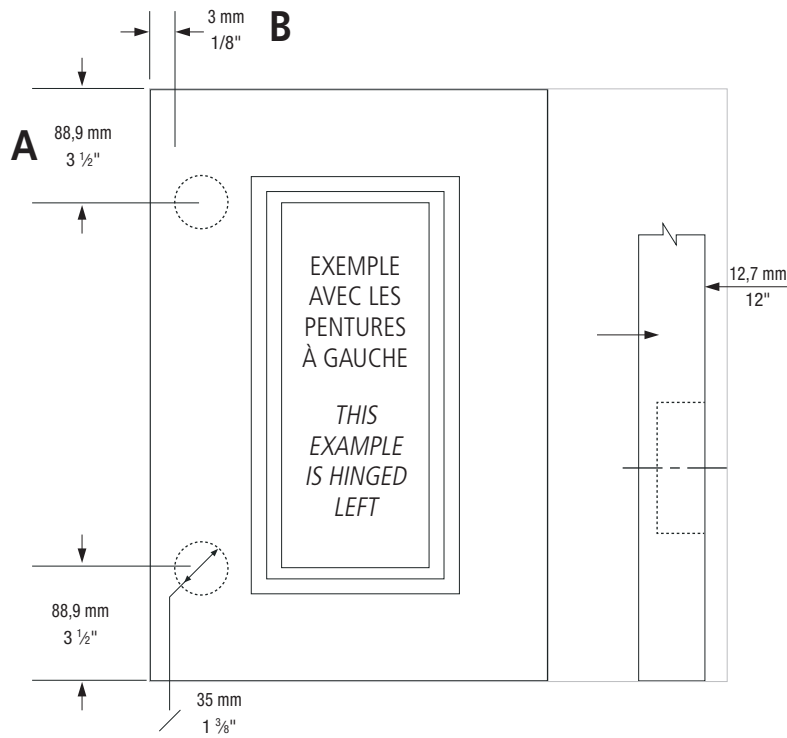

Diamètre du trou: 35 mm (1 3/8 po)

Profondeur: 12,7 mm (1/2 po)

Emplacement:

- pour les portes de 254 mm (10 po) et plus, à 3 mm (1/8 po) du bord et centré à 88,9 mm (3 1/2 po) du haut et du bas de la porte.
- pour les portes de moins de 254 mm (10 po), à 3 mm (1/8 po) du bord et centré à 63,5 mm (2 1/2 po) du haut et du bas de la porte.

Standard hinge hole diameter: 35 mm (1 3/8 in)

Standard depth: 12,7 mm (1/2 in)

Standard location:

- for doors 254 mm (10 in) and over, 3 mm (1/8 in) from side and centered at 88.9 mm (3 1/2 in) from top or bottom edge of the door.
- for doors less than 254 mm (10 in), 3 mm (1/8 in) from side and centered at 63.5 mm (2 1/2 in) from top or bottom edge of the door.

Hauteur de la porte / Door height		Nombre de pentures à respecter / Number of hinges required
mm	po / in	
0 à 899,16	0 à 35,4	2
899,17 à 1000,8	35,5 à 39,4	3
1000,9 à 1991,4	39,5 à 78,4	4
1991,5 à 2438,4	78,5 à ,96	5

Pour les portes nécessitant plus de deux pentures, s.v.p. fournir un dessin indiquant l'emplacement exact des trous.

Les grandeurs minimales indiquées pour chaque modèle de porte doivent être respectées afin d'assurer le dégagement nécessaire pour l'installation des pentures. /

For doors requiring more than 2 hinges, a drawing indicating actual position of the hinge holes is required. Minimum sizes indicated for each door model must be respected due to hinge clearance considerations.

RESISTANCE ENTRETIEN ET RÉPARATION DU PRODUIT

Faciles d'entretien, les portes polyester et mélamine d'Avanti peuvent être nettoyées avec de l'eau et du savon doux. Comme pour tout produit de qualité, certaines précautions peuvent être prises afin d'en préserver l'apparence :

- Éviter les poudres abrasives car le produit est sensible aux solvants organiques et récurrents abrasifs, particulièrement à l'acétone et au toluène.
- Éviter tout contact avec un objet pointu ou coupant de façon à ne pas égratigner les portes.
- Éviter d'exposer le produit à toute chaleur excessive. Pour éviter tout dommage causé par la chaleur excessive, suivre les instructions suivantes :
 1. Si la porte du fourneau est ouverte lorsque celui-ci est en marche au mode grillage, ouvrir les portes et tiroirs des armoires adjacentes.
 2. Lors du cycle auto-nettoyage du four, ouvrir ou enlever les portes et tiroirs des armoires adjacentes.
 3. Les appareils tels que cafetière, grille-pain et bouilloire ne doivent pas être mis en marche sur le comptoir s'ils sont placés directement sous les armoires.

PRODUCT CARE AND MAINTENANCE

Avanti polyester and melamine doors can be easily cleaned with mild soap and water. However, as with any quality product, there are certain precautions you can take to preserve its value:

- Avoid the use of harsh chemicals, such as lacquer thinner, bleach or cleansers containing solvents or abrasives; especially avoid products containing toluene or acetone.
- Avoid bumping or hitting surface with a sharp object, since it could result in a permanent indentation or cut.
- Avoid exposure of doors and drawers with high heat. To ensure against damage to doors or drawers, please do the following:
 1. Open doors and drawers of adjacent cabinets to minimize exposure to high heat when broiling with the oven door open.
 2. Since the door seals on some ranges and ovens allow high heat to escape during the self cleaning cycle, as a precaution, open or remove doors and drawers of adjacent cabinets during the self cleaning cycle.
 3. Be aware of countertop appliances such as boilers, toasters and toaster ovens that create high heat conditions. They should not be directly under doors of overhead cabinets while in use.

RÉSISTANCE À LA CHALEUR

L'importance d'offrir des produits de qualité est primordiale chez Prémoulé. Dans cette optique, nous avons confié le mandat au Centre de Recherche Industrielle de Québec (CRIQ) d'effectuer des essais comparatifs de tolérance à la chaleur pour nos battants de portes en polyester. Nos données techniques ont su démontrer l'endurance et l'adhérence du revêtement utilisé dans la fabrication des portes d'armoires en fonction de la température. L'étude a démontré que jusqu'à 100° C, aucune altération a été notée sur les battants de portes. L'objectif a été réalisé dans l'esprit de la satisfaction des besoins de nos clients ainsi qu'à fournir une concurrence hors pair dans l'industrie.

HEAT RESISTANCE

The importance of offering quality products is of the utmost importance at Prémoulé. With this aim in mind, we contracted the Centre de Recherche Industrielle de Québec (CRIQ) to perform comparative heat resistance tests for our polyester door panels. Our results have consistently shown the high heat endurance of the surface's material used in the door panel fabrication. This study showed that up to 100° C, no alteration was noted on the panels. Our exceptionally high standards in the industry were put to the test and the results proved to be very positive.



SPECIFICATIONS COMPOSANTES POUR PORTES NEXGEN

Les composantes pour portes 5 morceaux en laminés NEXGEN™ sont enrobées des mêmes imprimés et matériaux afin d'avoir une apparence quasi-parfaite avec la mélamine et le stratifié utilisés sur les côtés des cabinets avec une résistance à la décoloration. Les laminés NEXGEN™ de Olon offre une protection antibactérienne permanente ainsi qu'une résistance à la chaleur, aux égratignures et aux taches, qui les rend parfaits pour les maisons, les institutions de soins de santé, les écoles et les édifices commerciaux.

NEXGEN DOOR COMPONENTS

5-piece doors components in NEXGEN™ laminates are wrapped in the same materials and finishes to obtain a perfect match with the HPL and melamin cabinet door panels and offer a high resistance against discoloration. Olon's NEXGEN™ laminates offer a microbial protection allowing a higher heat and marking resistance, which makes them perfect for homes, hospitals, schools and commercial buildings.



Tableau de concordance / Compatible Color Options

#	Couleurs / Colors	Fini / Finish	Fournisseur / Supplier	Cat	Polyester						Mélamine	
					Tendance 45	Tendance 90	Delfino	Allegra	Fusion	Dolce	Panneau Uni	Shaker 90 / New Shaker 90
113	Blanc / White	Dolomite	Uniboard	C	P	P	P-C	P-C	P	P		
555	Blanc / White	Dolomite	Uniboard	C							P	P
H50	Silva	Orme brossé/ Wood Print Brushed Elm	Uniboard	E	P	P		P-C	P		P	P
H53	Cendré / Ember	Orme brossé/ Wood Print Brushed Elm	Uniboard	E	P	P		P-C	P		P	P
H54	Skye	Orme brossé/ Wood Print Brushed Elm	Uniboard	E	P	P		P-C	P	P	P	P
H55	Mystique / Mystic	Orme brossé/ Wood Print Brushed Elm	Uniboard	E	P	P		P-C	P		P	P
H70	Dérive / Driftwood	Orme brossé/ Wood Print Brushed Elm	Uniboard	E	P	P	P-C	P-C	P		P	P
H75	Tundra	Aura	Uniboard	C	P	P	P-C	P-C	P		P	P
K01	Muscade / Nutmeg	Aura	Uniboard	C	P	P				P	P	P
K02	Sésame / Sesame	Aura	Uniboard	C	P	P				P	P	P
K13	Nizza	Riviera	Uniboard	E	P	P		P-C	P	P	P	P
K14	Mistral	Riviera	Uniboard	E	P	P		P-C	P	P	P	P
K15	Cannes	Riviera	Uniboard	E	P	P		P-C	P	P	P	P
K16	Esterel	Riviera	Uniboard	E	P	P		P-C	P	P	P	P
K17	Cassis	Riviera	Uniboard	E	P	P		P-C	P	P	P	P
K23	Shanshu	Sequoia	Uniboard	C	P	P		P-C	P	P	P	P
K24	Dalia	Sequoia	Uniboard	C	P	P		P-C	P	P	P	P
K45	Vague bleue / Blue Wave	Vellum	Uniboard	F	P	P		P	P		P	P
K60	Mousseline / Chiffon	Nobella	Uniboard	E	P	P		P	P		P	P
K61	Soie / Silk	Nobella	Uniboard	E	P	P		P	P		P	P
K62	Plume blanche / Feather White	Nobella	Uniboard	E	P	P		P	P		P	P
K63	Pieta	Nobella	Uniboard	E	P	P		P	P		P	P
K64	Ombre	Nobella	Uniboard	E	P	P		P	P		P	P
K65	Americana	Nobella	Uniboard	E	P	P		P	P		P	P
K66	Murmure / Whisper	Nobella	Uniboard	E	P	P		P	P		P	P
K67	Rumeur / Rumour	Nobella	Uniboard	E	P	P		P	P		P	P
K71	Élémental / Elemental	Omnia	Uniboard	E	P	P		P	P		P	P
K82	Fumée blanche / White Smoke	Omnia	Uniboard	C							P	P
K83	Shipshaw	Omnia	Uniboard	C							P	P
K84	Quiétude / Quietude	Omnia	Uniboard	C							P	P
K88	Stellaire / Stellar	Omnia	Uniboard	C	P	P		P	P		P	P
K95	Atome / Atom	Omnia	Uniboard	C	P	P		P	P		P	P
L004	Flavie / Flavie	Aura	Uniboard	C	P	P		P	P		P	P
L005	Natura	Omnia	Uniboard	C	P	P		P	P		P	P
L009	Ioniq	Omnia	Uniboard	C	P	P		P	P		P	P
L100	Orchidée vanillée / Vanilla orchid	Crystalite	Tafisa	C	P	P	P-C	P-C	P	P		
L105	Bordée de neige / Snowfall	Crystalite	Tafisa	A	P	P		P-C	P	P		
L204	Ivoire / Ivory	Crystalite	Tafisa	C	P	P	P-C	P-C	P		P	P
L444	Poirier chocolaté / Chocolate Pear Tree	Crystalite	Tafisa	C	P	P		P-C	P		P	P
L492	Chocolat blanc / White chocolate	Urbania	Tafisa	C	P	P	P-C	P-C	P	P	P	P
L493	Chocolat au lait / Milk Chocolate*	Urbania	Tafisa	C	P	P		P-C	P		P	P
L495	Portobello*	Urbania	Tafisa	C	P	P		P-C	P			

Tableau de concordance / Compatible Color Options

#	Couleurs / Colors	Fini / Finish	Fournisseur / Supplier	Cat	Polyester						Mélamine	
					Tendance 45	Tendance 90	Delfino	Allegra	Fusion	Dolce	Panneau Uni	Shaker 90 / New Shaker 90
L530	Latitude nord / Latitude North	Alto	Tafisa	C	P	P		P-C	P	P	P	P
L532	Latitude ouest / Latitude West	Alto	Tafisa	C	P	P		P-C	P		P	P
L543	Bourgeon du printemps / Spring Blossom*	Alto	Tafisa	C	P	P		P-C	P			
L580	Esprit Libre / Free Spirit	Karisma	Tafisa	C	P	P		P	P		P	P
L581	Beauté Naturelle / Sheer Beauty	Karisma	Tafisa	C	P	P		P	P		P	P
L582	Fashionista	Karisma	Tafisa	C	P	P		P	P		P	P
L583	Première Classe / First Class	Karisma	Tafisa	C	P	P		P	P		P	P
L584	Le Caméléon / The Chameleon	Karisma	Tafisa	C	P	P		P	P		P	P
L585	Rapsodie / Rhapsody	Karisma	Tafisa	C	P	P		P	P		P	P
L586	Atomes Crochus / Natural Affinity	Karisma	Tafisa	C	P	P		P	P		P	P
L587	Rage de Sucre / Sugar Rush	Karisma	Tafisa	C	P	P		P	P		P	P
L588	Sucré-Salé / Sweet & Savory	Karisma	Tafisa	C	P	P		P	P		P	P
L589	Sel de la Terre / Salt of the Earth	Karisma	Tafisa	C	P	P		P	P		P	P
L590	Coup de Foudre / Love at First Sight	Karisma	Tafisa	C	P	P		P	P		P	P
L591	Miel d'Acacia / Acacia Honey	Karisma	Tafisa	C	P	P		P	P		P	P
L592	Accroche-Cœur / Kiss Curl	Karisma	Tafisa	C	P	P		P	P		P	P
L593	Éminence Grise / Mastermind	Karisma	Tafisa	C	P	P		P	P		P	P
L761	Clair de lune / Moonlight	Crystalite	Tafisa	C							P	P
L763	Rosée du matin / Morning Dew	Crystalite	Tafisa	C							P	P
L764	Au petit matin / Daybreak	Crystalite	Tafisa	C							P	P
L768	Tombée du jour / Sundown	Crystalite	Tafisa	C	P	P		P-C	P			
L807	Cerisier Brunito / Brunito Cherry	Crystalite	Tafisa	C	P	P	P-C	P-C	P		P	P
M2002	Virée en CabRiolet / Sunset Cruise	Viva	Tafisa	E	P	P		P-C	P	P	P	P
M2003	Folle Escapade / Weekend Getaway	Viva	Tafisa	E	P	P		P-C	P	P	P	P
M2004	Bain de Neige / Winter Fun	Viva	Tafisa	E	P	P		P-C	P	P	P	P
M2005	Brunch Festif / Sunday Brunch	Viva	Tafisa	E	P	P		P-C	P	P	P	P
M2006	Tea for Two	Viva	Tafisa	E	P	P		P-C	P	P	P	P
M2007	Preneur de l'aube / Casting at First Light	Viva	Tafisa	E	P	P		P-C	P	P	P	P
M2010	After - Hours	Viva	Tafisa	E	P	P		P-C	P	P	P	P
M2015	Après-Ski	Viva	Tafisa	E	P	P		P-C	P	P	P	P
M2035	Cravate noire / Black Tie*	Brava	Tafisa	E							P	P
M2036	Spa nordique*	Brava	Tafisa	E							P	P
M2056	Oiseau de nuit / Night Owl*	Feria	Tafisa	E							P	P
P207	Cerisier choco / Choco Cherry	Dolomite	Uniboard	C	P	P	P-C	P-C	P		P	P
P555	Nova Blanc / Nova White	Orme brossé/ Wood Print Brushed Elm	Uniboard	E							P	P
WF226	Zambukka	Medina	Arauco	C	P	P		P	P		P	P
WF340	Aria	Medina	Arauco	C	P	P		P	P		P	P
WF375	Diva	Medina	Arauco	C	P	P		P	P		P	P
WF392	Réglisse rainurée / Licorice Groovz	Authentick	Arauco	C	P	P		P	P		P	P
WF393	Béton rainurée / Concrete Groovz	Authentick	Arauco	C	P	P		P	P		P	P
WF394	Arctique rainuré / Artic Groovz	Authentick	Arauco	C	P	P		P	P		P	P

* Disponibles jusqu'à épuisement des stocks / Availables until stock is depleted. ** Discontinué / Discontinued.

C: Carrelage / Multiple Mullion. P: Plat / Flat.

Disponibles pour les collections Avanti et Mélamine. / Available for Avanti and Melamine collections.

Offre de couleurs / Color Offer

arauco

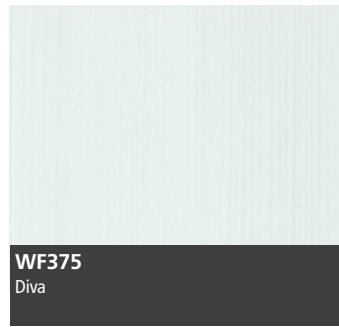

WF375
Diva



WF394
Arctique rainuré
Arctic Groovz



WF393
Béton rainuré
Concrete Groovz



WF340
Aria



WF392
Réglisse rainurée
Licorice Groovz

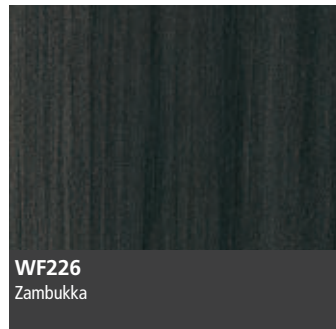

WF226
Zambukka

TAFISA

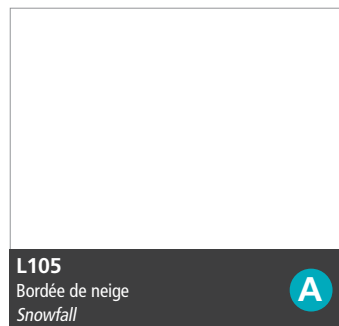

L105
Bordée de neige
Snowfall

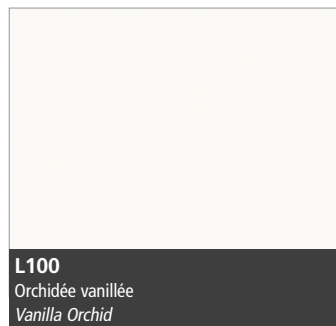

L100
Orchidée vanillée
Vanilla Orchid

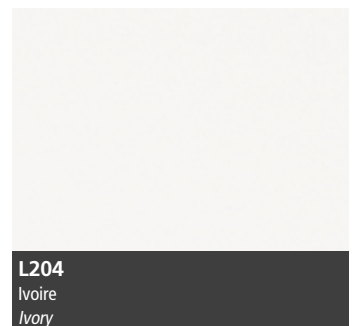

L204
Ivoire
Ivory



L530
Latitude nord
Latitude North

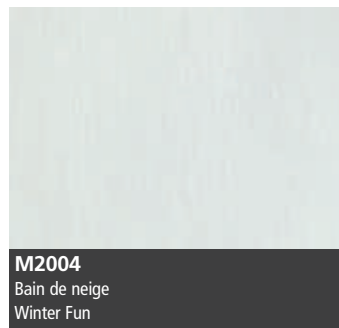

M2004
Bain de neige
Winter Fun

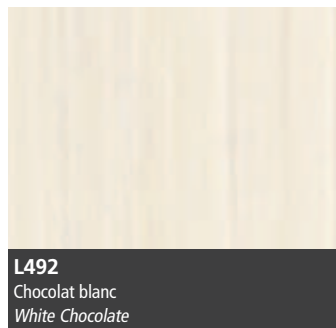

L492
Chocolat blanc
White Chocolate



M2003
Folle escapade
Weekend Getaway

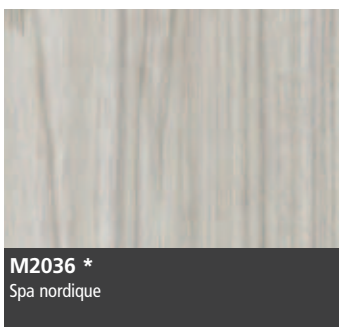

M2036 *
Spa nordique

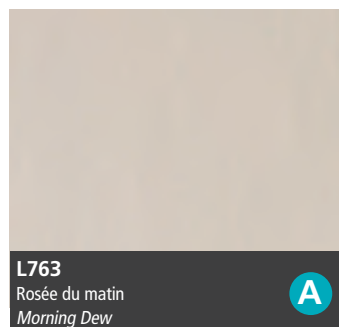

L763
Rosée du matin
Morning Dew



M2007
Preneur de l'aube
Casting First Light



L590K
Coup de Foudre
Love at First Sight



Offre de couleurs / Color Offer

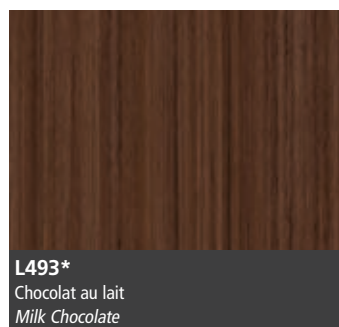
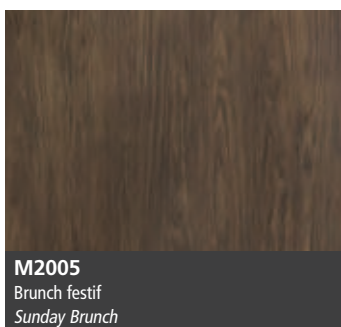
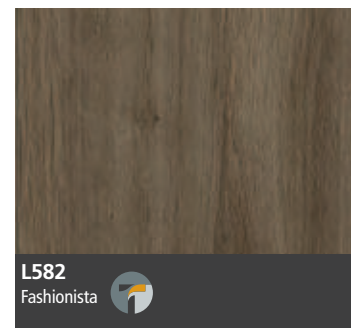
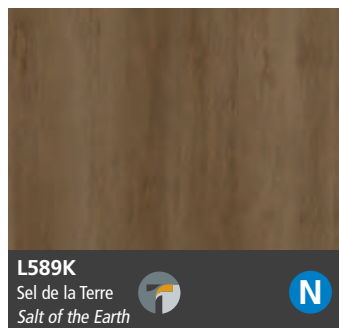
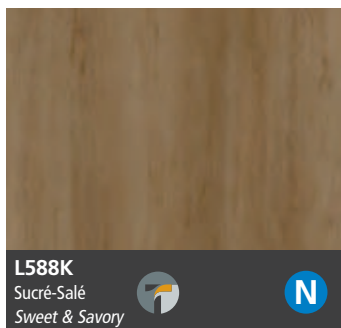
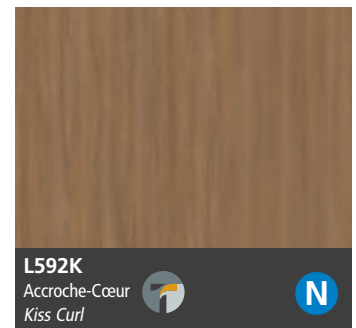
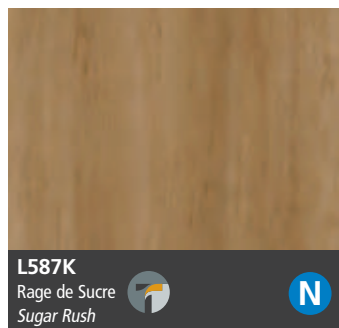
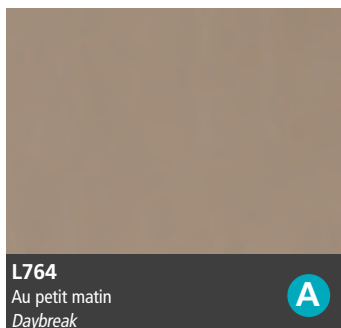
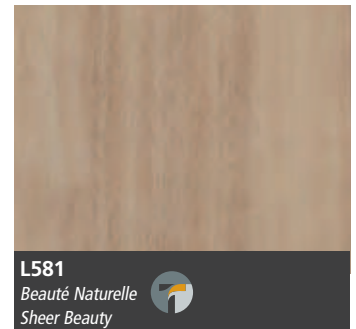
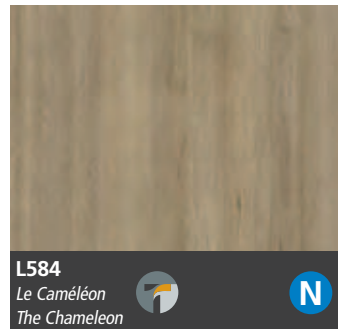
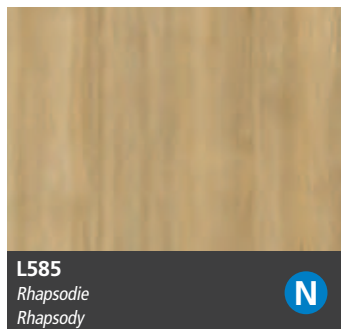
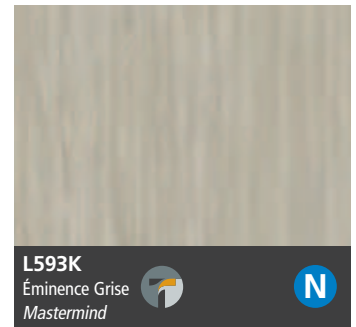
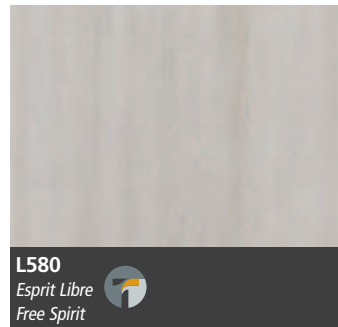
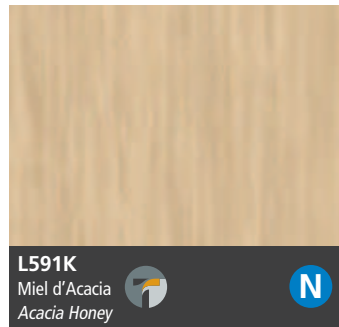
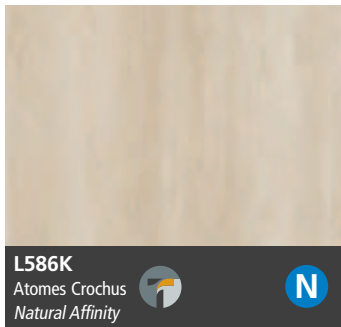

N Nouveau / New

A Couleur Avantage / Advantage Colors

Informez-vous auprès du service à la clientèle pour connaître le distributeur autorisé de votre région.

Disponible pour les collections Avanti et mélamine. /

Contact customer service for information on your local authorized distributor.

Available for Avanti and Melamine collection.

Offre de couleurs / Color Offer

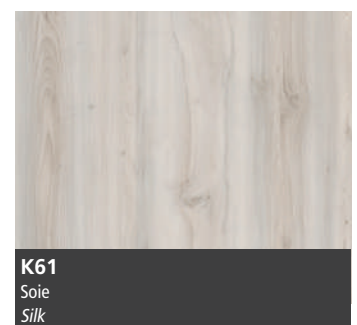
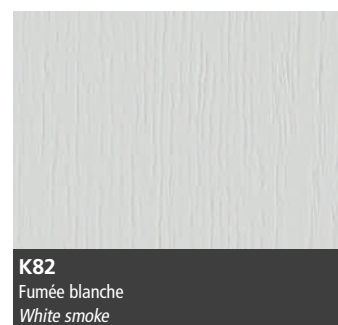
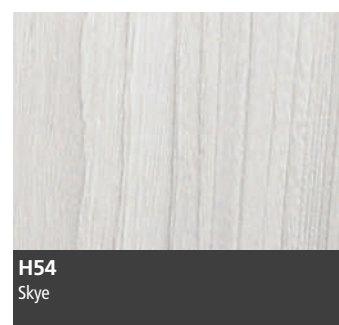
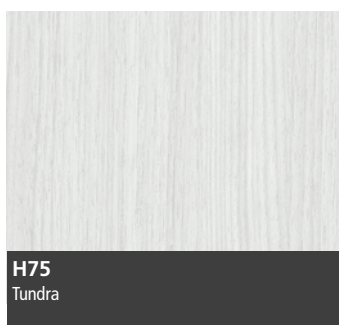
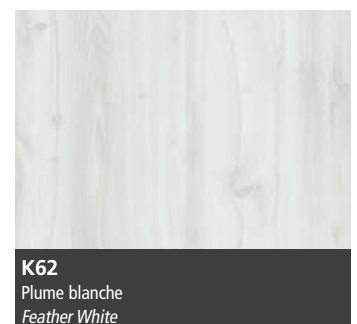
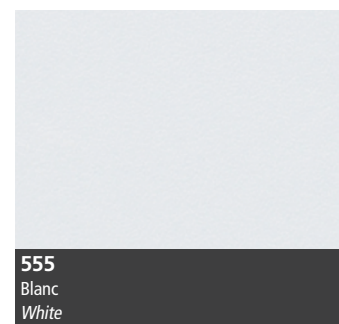
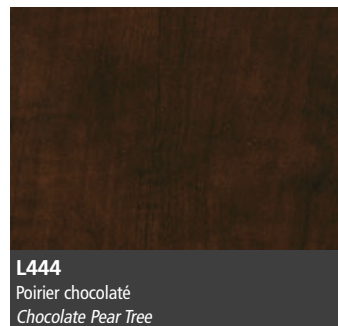
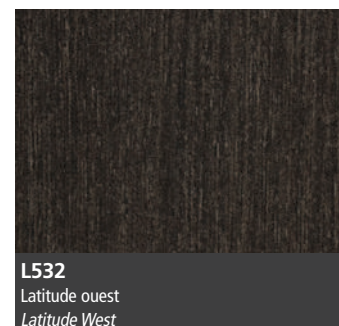
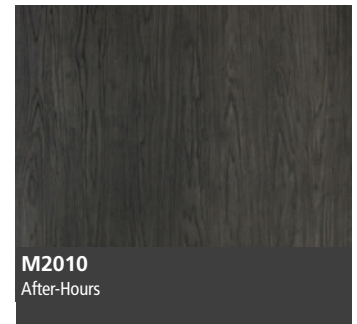
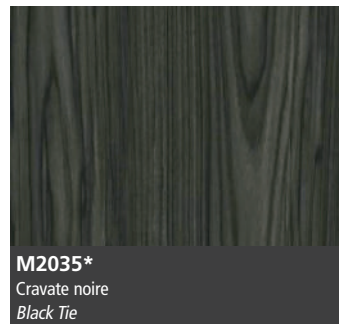
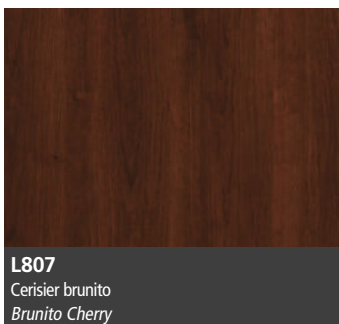
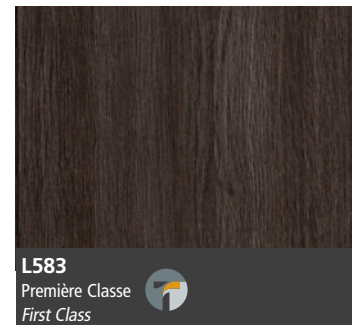
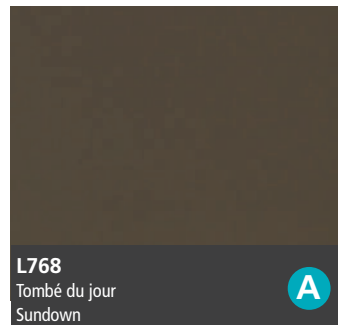
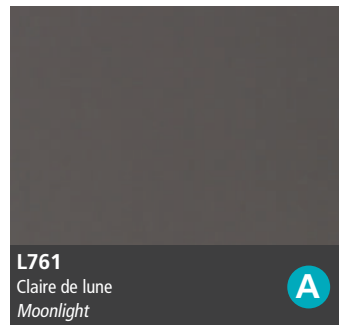
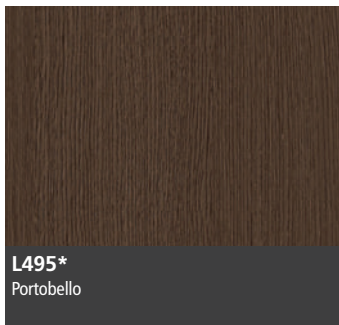

Offre de couleurs / Color Offer

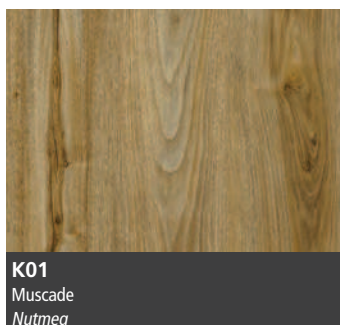
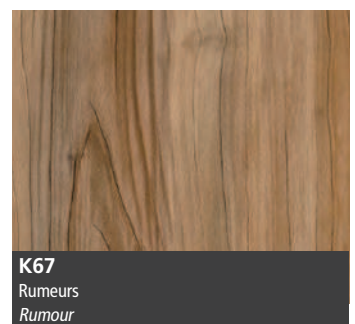
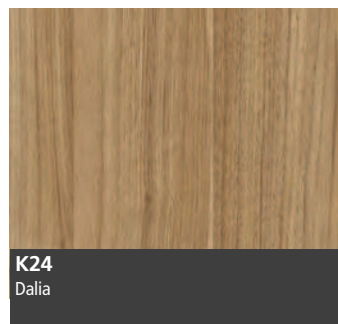
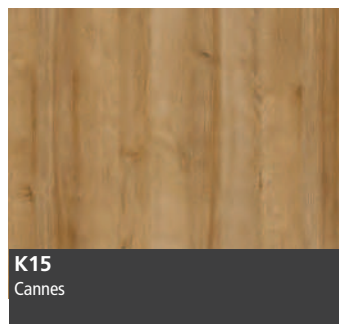
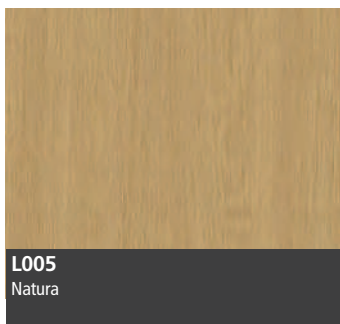
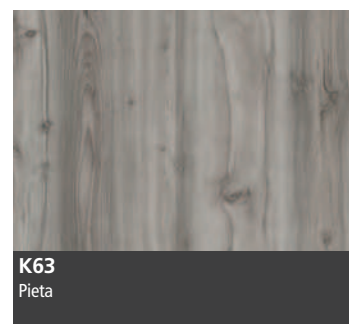
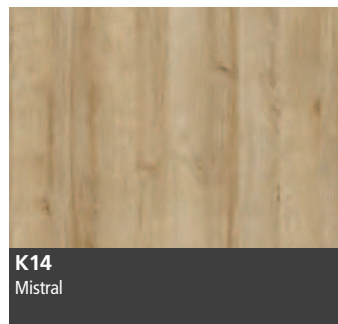
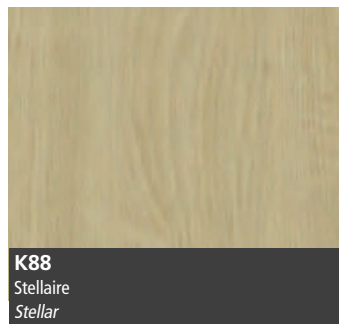
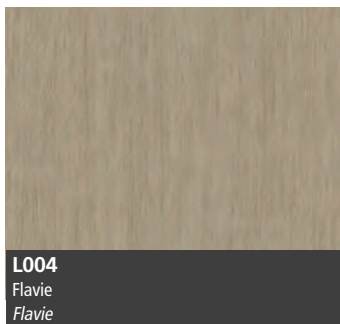
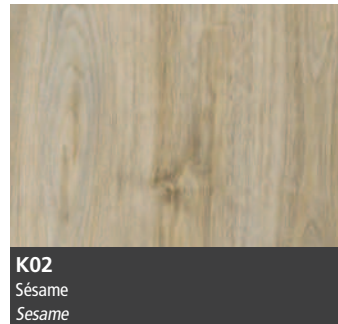
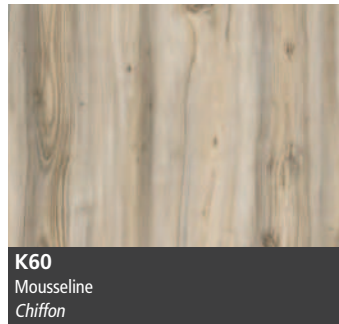
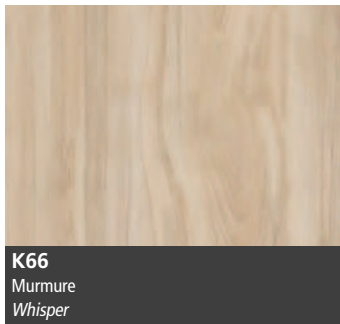
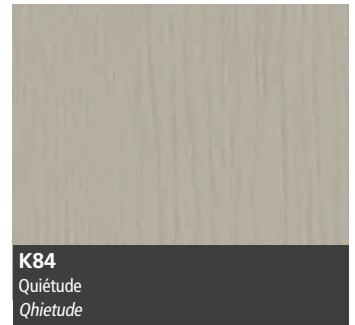
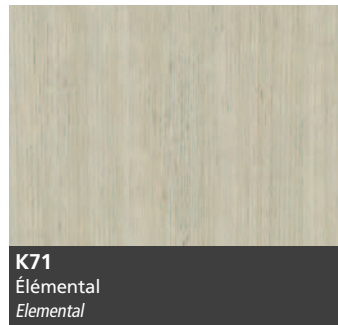
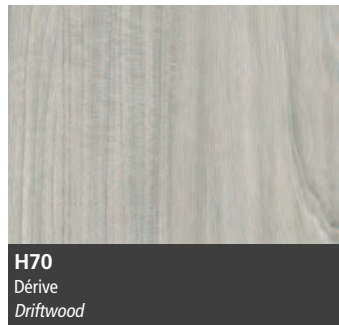
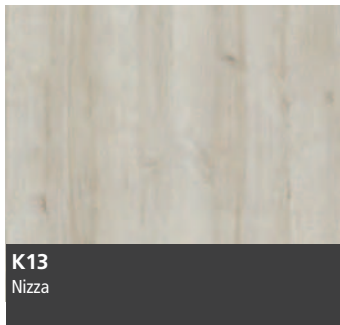

A Couleur Avantage / *Avantage Colors*

Informez-vous auprès du service à la clientèle pour connaître le distributeur autorisé de votre région.

Disponible pour les collections Avanti et Mélamine. /

Contact customer service for information on your local authorized distributor.

Available for Avanti and Melamine collection.

Offre de couleurs / *Color Offer*

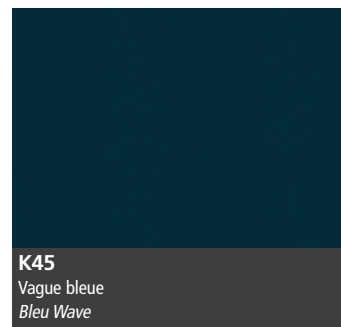
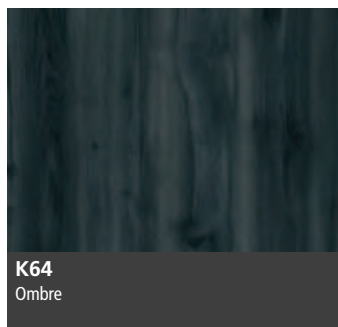
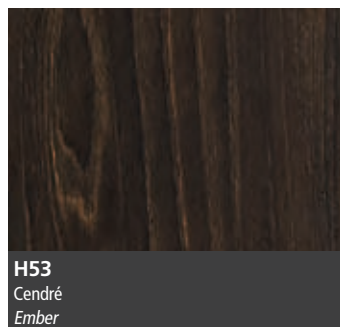
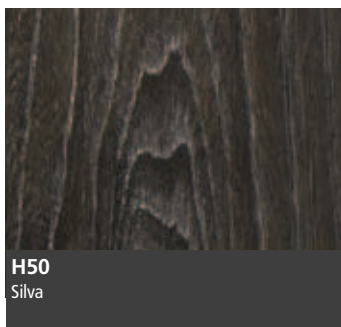
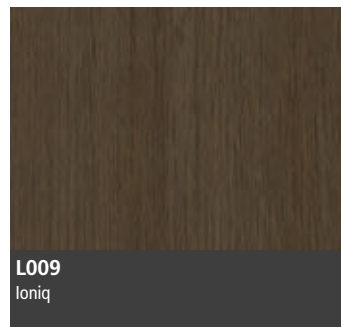
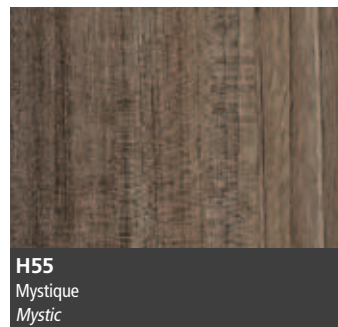
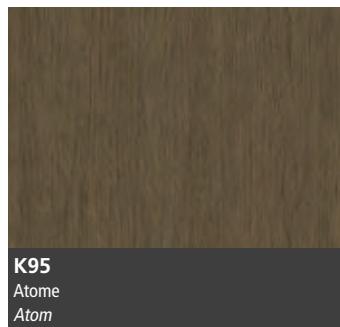
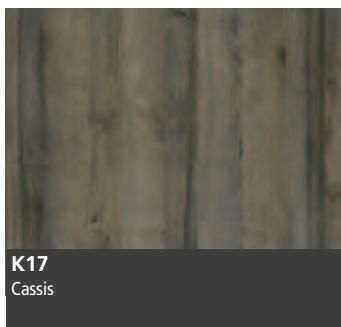
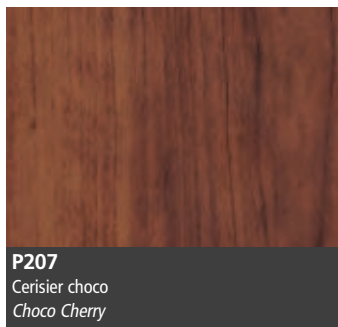
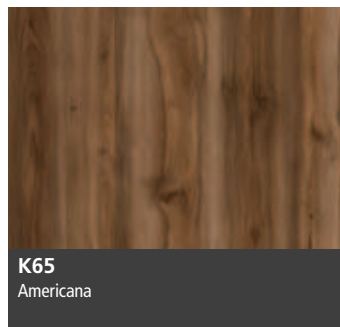
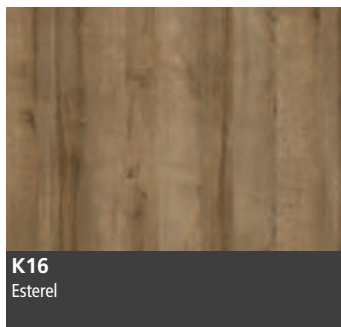

Informez-vous auprès du service à la clientèle pour connaître le distributeur autorisé de votre région.

Disponible pour les collections Avanti et mélamine. /

Contact customer service for information on your local authorized distributor.

Available for Avanti and melamine collection.



ÉVOLUTION PURTFLEX, ONYX 90, L581

COLLECTION ÉVOLUTION PURTFLEX

SAPHIR | ONYX | AZUR | RUBY

SAPHIR



Modèle / Model **8814**
 Couleur / Color
 PTFWF432 Alabastar

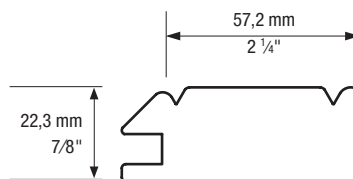

Modèle / Model	Type de modèle / Type of model	Dimensions minimales / Minimum dimensions (Hauteur x Largeur / Height x width)
8814	Porte et tiroir centre plat / Flat door and drawer front	5 1/4 x 5 1/4 po / in 133,35 X 133,35 mm
8854	Verrière / Frame door	Voir page 38 / See page 38

Portes avec grain de bois vertical, largeur maximale de 29 po (736,6 mm), aucun maximum sur la hauteur. Pour les tiroirs, le grain de bois est standard horizontal. /

Doors with vertical woodgrain, maximum width of 29 in (736,6 mm), no maximum height. Drawer front standard is with horizontal woodgrain.

ONYX

ONYX 45



Modèle / Model **8114**
Couleur / Color
PTFWF435 Palomino

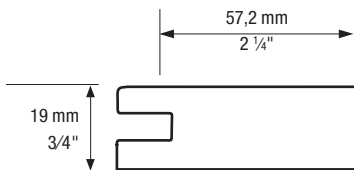

ONYX 90



Modèle / Model **9114**
Couleur / Color
PTFWF435 Palomino

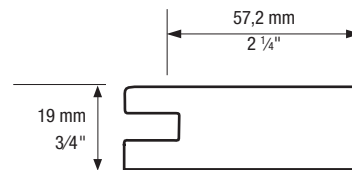

Modèle / Model	Type de modèle / Type of model	Dimensions minimales / Minimum dimensions (Hauteur x Largeur / Height x width)
8114	Porte et tiroir centre plat / Flat door and drawer front	5 1/4 x 5 1/4 po / in 133,35 X 133,35 mm
8154	Verrière / Frame door	Voir page 38 / See page 38

Modèle / Model	Type de modèle / Type of model	Dimensions minimales / Minimum dimensions (Hauteur x Largeur / Height x width)
9114	Porte et tiroir centre plat / Flat door and drawer front	5 1/4 x 6 1/2 po / in 133,35 X 165,10 mm
9154	Verrière / Frame door	Voir page 38 / See page 38

Portes avec grain de bois vertical, largeur maximale de 29 po (736,6 mm), aucun maximum sur la hauteur. Pour les tiroirs, le grain de bois est standard horizontal. Surcharge sur traverse pour le modèle shaker. Panneaux multiples offerts.

Portes assemblées 45° / 90° de plus de 42 po :

- sans traverse centrale : la garantie contre le gauchissement ne sera pas applicable
- avec traverse centrale : la garantie contre le gauchissement sera applicable. /

Doors with vertical woodgrain, maximum width of 29 in (736,6 mm), no maximum height. Drawer front standard is with horizontal woodgrain. Upcharge for shaker with frame. Multiple panels available.

Doors with 45° / 90° degree assembly over 42 in :

- Without middle cross-rail: will not carry any guarantee against warpage.
- With a middle crosspiece: will be guaranteed against warpage.

Portes avec grain de bois vertical, largeur maximale de 29 po (736,6 mm), aucun maximum sur la hauteur. Pour les tiroirs, le grain de bois est standard horizontal. Surcharge sur traverse pour le modèle shaker. Panneaux multiples offerts.

Portes assemblées 45° / 90° de plus de 42 po :

- sans traverse centrale : la garantie contre le gauchissement ne sera pas applicable
- avec traverse centrale : la garantie contre le gauchissement sera applicable. /

Doors with vertical woodgrain, maximum width of 29 in (736,6 mm), no maximum height. Drawer front standard is with horizontal woodgrain. Upcharge for shaker with frame. Multiple panels available.

Doors with 45° / 90° degree assembly over 42 in :

- Without middle cross-rail: will not carry any guarantee against warpage.
- With a middle crosspiece: will be guaranteed against warpage.

AZUR 45



Modèle / Model **8914**
Couleur / Color
PTFWF434 Gibraltar

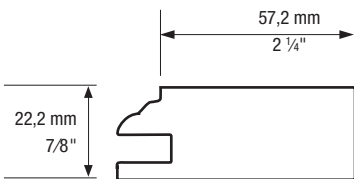
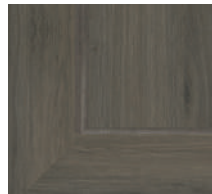

AZUR 90



Modèle / Model **9914**
Couleur / Color
PTFWF434 Gibraltar

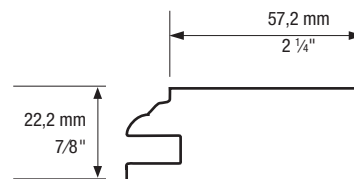
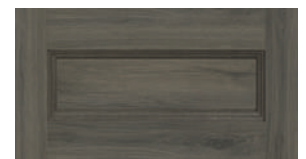

Modèle / Model	Type de modèle / Type of model	Dimensions minimales / Minimum dimensions (Hauteur x Largeur / Height x width)
8914	Porte et tiroir centre plat / Flat door and drawer front	5 1/4 x 5 1/4 po / in 133,35 X 133,35 mm
8954	Verrière / Frame door	Voir page 38 / See page 38

Portes avec grain de bois vertical, largeur maximale de 29 po (736,6 mm), aucun maximum sur la hauteur. Pour les tiroirs, le grain de bois est standard horizontal. /

Doors with vertical woodgrain, maximum width of 29 in (736,6 mm), no maximum height. Drawer front standard is with horizontal woodgrain.

Modèle / Model	Type de modèle / Type of model	Dimensions minimales / Minimum dimensions (Hauteur x Largeur / Height x width)
9914	Porte et tiroir centre plat / Flat door and drawer front	5 1/4 x 8 1/2 po / in 133,35 X 215,90 mm
9954	Verrière / Frame door	Voir page 38 / See page 38

Portes avec grain de bois vertical, largeur maximale de 29 po (736,6 mm), aucun maximum sur la hauteur. Pour les tiroirs, le grain de bois est standard horizontal. /

Doors with vertical woodgrain, maximum width of 29 in (736,6 mm), no maximum height. Drawer front standard is with horizontal woodgrain.

RUBY

RUBY 45



Modèle / Model **8714**
 Couleur / Color
 PTF11682SF
 Chêne doux / Mellow Oak

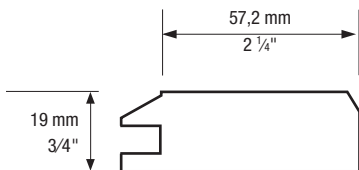

RUBY 90



Modèle / Model **9714**
 Couleur / Color
 PTF11682SF
 Chêne doux / Mellow Oak

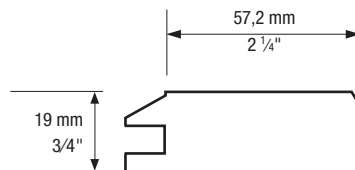

Modèle / Model	Type de modèle / Type of model	Dimensions minimales / Minimum dimensions (Hauteur x Largeur / Height x width)
8714	Porte et tiroir centre plat / Flat door and drawer front	5 1/4 x 5 1/4 po / in 133,35 X 133,35 mm
8754	Verrière / Frame door	Voir page 38 / See page 38

Modèle / Model	Type de modèle / Type of model	Dimensions minimales / Minimum dimensions (Hauteur x Largeur / Height x width)
9714	Porte et tiroir centre plat / Flat door and drawer front	5 1/4 x 8 1/2 po / in 133,35 X 215,90 mm
9754	Verrière / Frame door	Voir page 38 / See page 38

Portes avec grain de bois vertical, largeur maximale de 29 po (736,6 mm), aucun maximum sur la hauteur. Pour les tiroirs, le grain de bois est standard horizontal. /

Doors with vertical woodgrain, maximum width of 29 in (736.6 mm), no maximum height. Drawer front standard is with horizontal woodgrain.

Portes avec grain de bois vertical, largeur maximale de 29 po (736,6 mm), aucun maximum sur la hauteur. Pour les tiroirs, le grain de bois est standard horizontal. /

Doors with vertical woodgrain, maximum width of 29 in (736.6 mm), no maximum height. Drawer front standard is with horizontal woodgrain.

Tableau de concordance / Compatible Color Options

#	Couleurs / Colors	Fournisseur / Supplier	Cat	Saphir	Onyx 45-90	Ruby 45-90	Azur 45-90
PTF777	Blanc / White	Uniboard	A	•	•	•	•
PTF300	Blanc classique / Classic White	Uniboard	C	•	•	•	•
PTFS463*	Blanc antique / Antique White	Panolam	B	•	•	•	•
PTF777B	Blanc bois / White Wood Grain	Uniboard	A	•	•	•	•
PTFWZ049GB*	Crema	Panolam	B	•	•	•	•
PTFWF432	Alabaster	arauco	C	•	•		•
PTF10632SF	Marges blanches / White Margins	Merino	C	•	•	•	•
PTFWF433	Argento	arauco	C	•	•		•
PTF11682SF	Chêne doux / Mellow Oak	Merino	C	•	•	•	•
PTFWF441*	Burlap	arauco	C	•	•		•
PTF14693SF	Chêne fumé Rovere / Smoked Rovere Oak	Merino	C	•	•	•	•
PTFWF435	Palomino	arauco	C	•	•		•
PTFWF011GB*	Macchiato	Panolam	B	•	•	•	•
PTFW379GB*	S'mores	Panolam	B	•	•	•	•
PTF14675SF	Ébène Sépia / Ebony Sepia	Merino	C	•	•	•	•
PTF14694SF	Chêne noir indien / Hinds Black Oak	Merino	C	•	•	•	•
PTFWZ055GB*	Carajillo	Panolam	B	•	•	•	•
PTFW150GB*	Acajou absolu / Absolute Acajou	Panolam	B	•	•	•	•
PTFWF434	Gibraltar	arauco	C	•	•		•
PTF14621SF	Châtaignier Nunavut / Chestnut Nunavut	Merino	C	•	•	•	•
PTFWK024GB*	Palazzo	Panolam	B	•	•	•	•
PTFWF446*	Charred Oak	arauco	C	•	•		•
L580	Esprit Libre / Free Spirit	Tafisa	E		•	•	
L581	Beauté Naturelle / Sheer Beauty	Tafisa	E		•	•	
L582	Fashionista	Tafisa	E		•	•	
L583	Première Classe / First Class	Tafisa	E		•	•	

* Disponibles jusqu'à épuisement des stocks / Availables until stock is depleted.



DURABILITÉ SANS PAREILLE
UNPARALLELED DURABILITY



HAUTE DÉFINITION
HIGH PRECISION



FAÇILE D'ENTRETIEN
EASY TO MAINTAIN



RÉSISTANCE TRÈS ÉLEVÉE
AUX RAYURES
EXCELLENT SCRATCH
RESISTANCE



HAUTE STABILITÉ AUX UV
HIGH UV STABILITY

Technologie unique dans le domaine de l'enrobage, le PurTflex consiste à extruder une mince couche de polyuréthane recouverte d'une couche de vernis UV sur un papier décoratif spécialement traité au polyuréthane.

PURTFLEX UNE TECHNOLOGIE RESPECTUEUSE DE L'ENVIRONNEMENT

Les portes PurTflex ont reçu l'attestation de conformité BIFMA X7.1 du CRIQ (Centre de recherche industrielle du Québec), certifiant que nos produits ne sont pas nocifs pour la santé ou l'environnement et répondent aux normes vertes visant l'émission de composés organiques volatiles (COV).

Prémoulé est fier d'offrir à ses clients un produit de haute qualité dans le respect de l'environnement et de l'humain.

PURLAM

Un produit de la gamme PurTflex qui allie durabilité et simplicité. Le PurTlam se compose du papier PurTflex laminé sur un support de carton. En plus d'y retrouver l'excellente qualité de finition et de résistance du produit, grâce à sa rigidité, cette technologie rend toutes les étapes de manipulation plus efficaces et plus uniformes. Ainsi le PurTlam est un produit à la précision inégalable sur le marché. Idéal pour le « refacing », le PurTlam peut très bien remplacer le stratifié. Grandeur disponible : 24 x 96 po.

A unique technology in the wrapping field, PurTflex consists of extruding a thin layer of polyurethane covered with a layer of UV varnish on a decorative paper specially treated with polyurethane.

PURTFLEX ENVIRONMENTALLY FRIENDLY TECHNOLOGY

In compliance with the BIFMA X7.1 certificate from CRIQ (Quebec Industrial Research Centre), PurTflex doors are certified not harmful to health or the environment and meet green standards of Volatile Organic Compound (VOC).

Prémoulé is proud to offer to its clients a high quality product that is respectful of the environment and individuals.

PURLAM

A new PurTflex product offering that combines durability and simplicity. The PurTlam consists of laminated PurTflex paper on a rigid cardboard. In addition to an excellent finishing quality and its hardeness, this technology makes every step more efficient for multiple handling. PurTlam offers an unparalleled accuracy and is ideal for refacing and a great alternative to laminates. Size available: 24 x 96 inches.

Offre de couleurs PurTflex / *PurTflex Color Offer*

arauco



PTFWF432
Alabaster



PTFWF433
Argento



PTFWF441*
Burlap



PTFWF435
Palomino



PTFWF434
Gibraltar



PTFWF446*
Charred Oak



PTF10632SF
Marges blanches
White Margins



PTF11682SF
Chêne doux
Mellow Oak



PTF14693SF
Chêne fumé Rovere
Smoked Rovere Oak

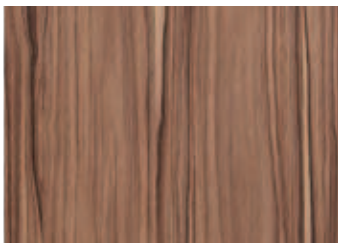

PTF14675SF
Ébène Sépia
Ebony Sepia



PTF14694SF
Chêne noir indien
Hinds Black Oak

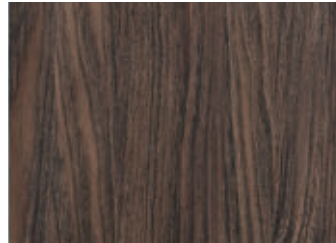

PTF14621SF
Châtaignier Nunavut
Chestnut Nunavut

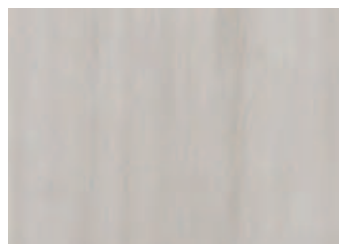

L580
Esprit Libre
Free Spirit



L581
Beauté Naturelle
Sheer Beauty

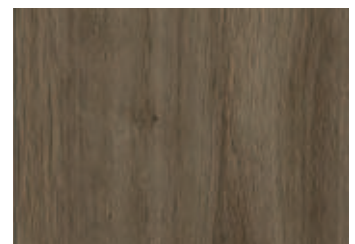

L582
Fashionista

TAFISA

Offre de couleurs PurTflex / *PurTflex Color Offer*

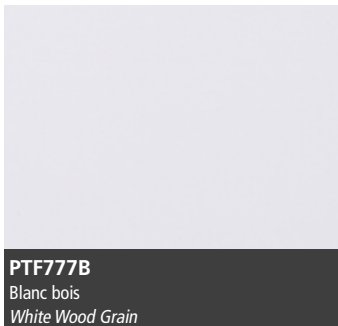
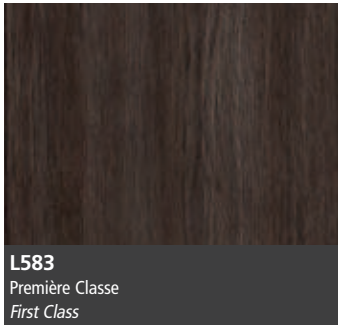

AUTRES / OTHERS

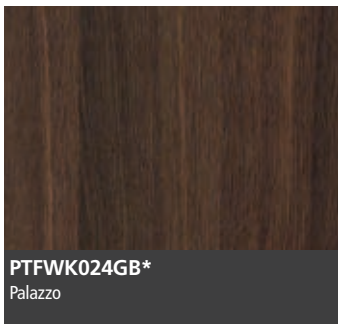
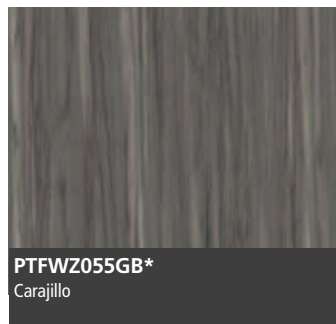
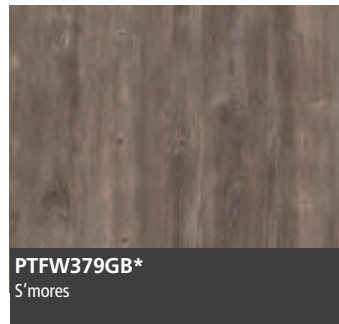
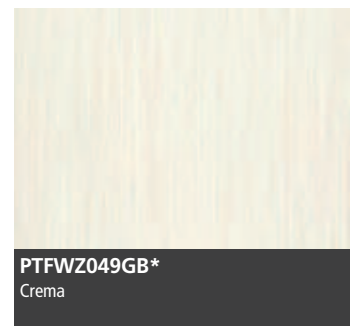
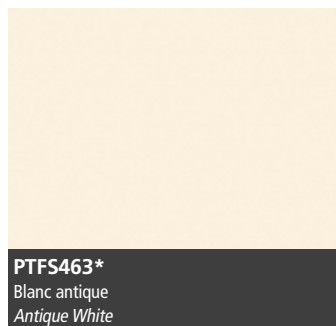

Pour connaître la disponibilité des couleurs, vous référez au tableau de concordance.

* Disponibles jusqu'à épuisement des stocks /

To know the availability, you can refer to the compatible color options page.

* Availables until stock is depleted.

Moulores et accessoires / Mouldings and accessories



9443 Moulure de Tête / Crown moulding
Longueur / Length: 9 pi/ft

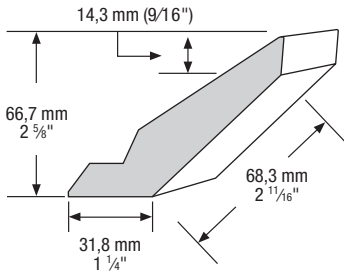

9432 Cache-néon / Light valance
Longueur / Length: 9 pi/ft

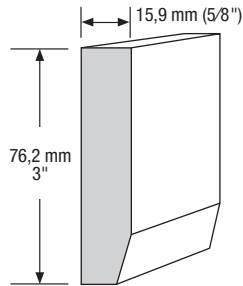

9433 Cache-néon / Light valance
Longueur / Length: 9 pi/ft

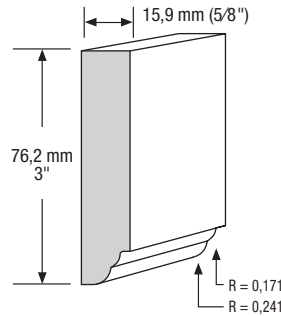

7432 Cache-néon réversible
Reversible light valance
Longueur / Length: 9 pi/ft

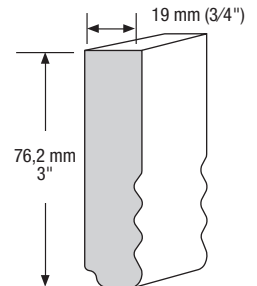

7443 Moulure de tête / Crown moulding
Longueur / Length: 9 pi/ft

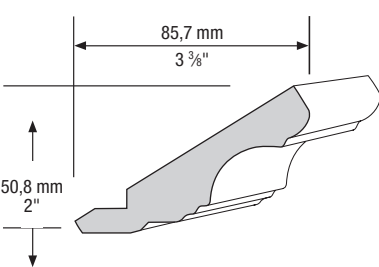

7446 Ogee
Longueur / Length: 9 pi/ft

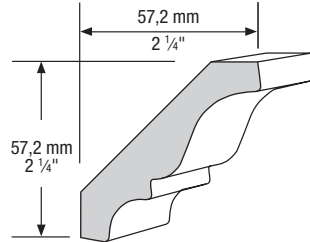

9446 Ogee
Longueur / Length: 9 pi/ft

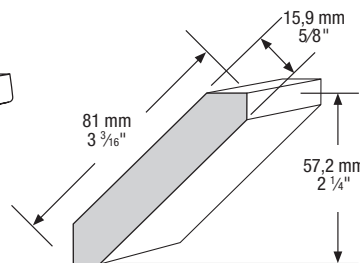

9447 Ogee
Longueur / Length: 9 pi/ft

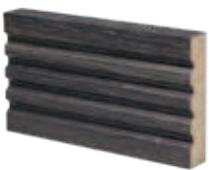
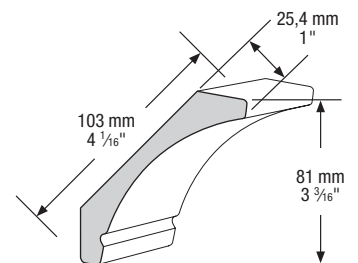

9410
Pilastre / Fluted filler
Longueur / Length: 8 pi/ft

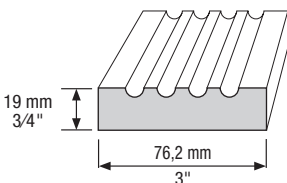

9414
Cadrage / Casing
Longueur / Length: 8 pi/ft

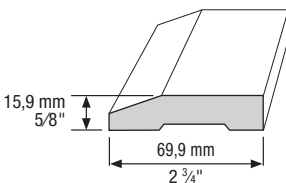

9415
Plinthe / Baseboard
Longueur / Length: 9 pi/ft

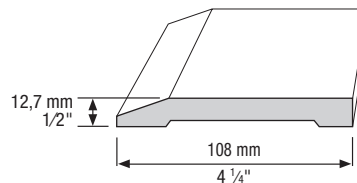

9717
Latte / Batten
Longueur / Length: 9 pi/ft

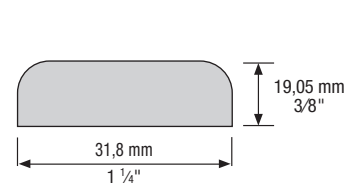

9432 - 9443 - 9446 - 9717: Disponible dans la fini Karisma / Available in Karisma Finish



ÉVOLUTION POLYESTER, SHAKER, WS503

COLLECTION ÉVOLUTION POLYESTER

SHAKER | BORÉAL | ALLURE | RIVAGE

Offre de couleur Polyester / Polyester Color Offer



Assurez-vous que votre chaînette soit toujours à jour.

* Informez-vous auprès du service à la clientèle pour connaître les modèles disponibles. /

Be sure your sample chain is always up-to-date.

** Contact customer service for available models.*

SHAKER / BORÉAL

SHAKER



Modèle / Model **7114**

Couleur / Color
WS503 Blanc / White

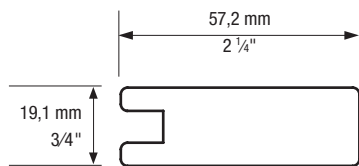
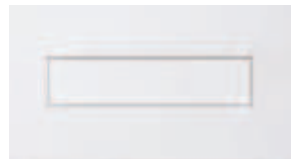

BORÉAL



Modèle / Model **7918**

Couleur / Color
WS503 Blanc / White

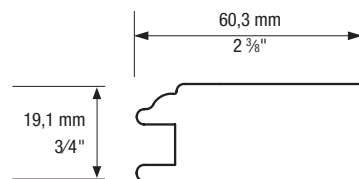

Modèle / Model	Type de modèle / Type of model	Dimensions minimales / Minimum dimensions (Hauteur x Largeur / Height x width)
7114	Centre plat / Flat centre panel	5 1/4 x 5 1/4 po / in 133,35 X 133,35 mm
7154	Verrière / Frame door	Voir page 38 / See page 38

Modèle / Model	Type de modèle / Type of model	Battant / Rail	Dimensions minimales / Minimum dimensions (Hauteur x Largeur / Height x width)
7918	Centre plat / Flat centre panel	2 3/8 po / in 60,3 mm	5 3/4 x 5 3/4 po / in 146,05 X 146,05 mm
7958	Verrière / Frame door		Voir page 38 / See page 38

Portes assemblées 45° / 90° de plus de 42 po :

- sans traverse centrale : la garantie contre le gauchissement ne sera pas applicable
- avec traverse centrale : la garantie contre le gauchissement sera applicable. /

Doors with 45° / 90° degree assembly over 42 in :

- Without middle cross-rail: will not carry any guarantee against warpage.
- With a middle crosspiece: will be guaranteed against warpage.

ALLURE



Modèle / Model **7517**

Couleur / Color
WS503 Blanc / White

Modèle / Model **7518**

Couleur / Color
WS503 Blanc / White



PORTES & TIROIRS
DOORS & DRAWERS

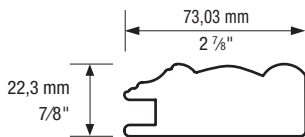

PORTES & TIROIRS
DOORS & DRAWERS

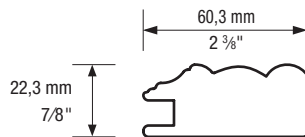

RIVAGE



Modèle / Model **7617**

Couleur / Color
WS503 Blanc / White

Modèle / Model **7614**

Couleur / Color
WS503 Blanc / White



PORTES & TIROIRS
DOORS & DRAWERS

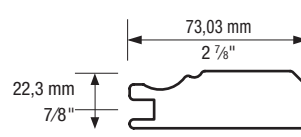

PORTES & TIROIRS
DOORS & DRAWERS

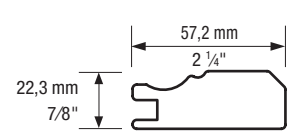

Modèle / Model	Type de modèle / Type of model	Battant / Rail	Dimensions minimales / Minimum dimensions (Hauteur x Largeur / Height x width)
7517	Centre plat / Flat centre panel	2 7/8 po / in 73,03 mm	6 1/2 x 6 1/2 po / in 165,1 X 165,1 mm
7557 7558	Verrière / Frame		Voir page 38 / See page 38

Modèle / Model	Type de modèle / Type of model	Battant / Rail	Dimensions minimales / Minimum dimensions (Hauteur x Largeur / Height x width)
7617	Centre plat / Flat centre panel	2 7/8 po / in 73,03 mm	6 1/2 x 6 1/2 po / in 165,1 X 165,1 mm
7654 7657	Verrière / Frame		Voir page 38 / See page 38

Évolution – Verrière / Frame Door

NOTES IMPORTANTES / IMPORTANT INFORMATION

Les portes sont vendues sans vitre. Également disponible, verrières de 2, 4, 6, 8 et 10 carreaux dans le modèle Shaker.
 Glass is not included. Also available, frame doors with 2, 4, 6, 8 & 10 glasses for our Shaker model.

INFORMATIONS TECHNIQUES / TECHNICAL INFORMATION

	# MODÈLE / MODEL	BATTANT / RAIL	DIMENSIONS MINIMALES / MINIMUM DIMENSIONS (Hauteur x Largeur / Height x Width)	MESURES POUR INSERTIONS DE VERRE / SIZES FOR GLASS INSERTS (Hauteur x Largeur / Height x Width)
SHAKER	7154	2 ¼ po / in 57,2 mm	5 ¼ x 5 ¼ po / in 133,35 x 133,35 mm	3 7/8 x 3 7/8 x po / in 98,4 x 98,4 mm

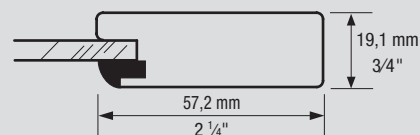

BORÉAL	7958	2 3/8 po / in 60,3 mm	5 3/4 x 5 3/4 po / in 146,05 x 146,05 mm	4 1/8 x 4 1/8 po / in 104,78 x 104,78 mm
--------	------	--------------------------	---	---

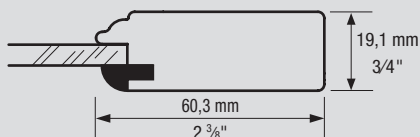

ALLURE	7558	2 3/8 po / in 60,3 mm	5 1/2 x 5 1/2 po / in 139,7 x 139,7 mm	4 1/8 x 4 1/8 po / in 104,78 x 104,78 mm
	7557	2 7/8 po / in 73,03 mm	6 1/2 x 6 1/2 po / in 165,1 x 165,1 mm	5 1/8 x 5 1/8 po / in 130,18 x 130,18 mm

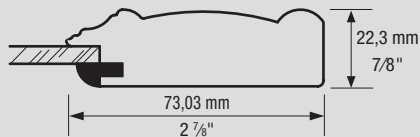

RIVAGE	7654	2 ¼ po / in 57,2 mm	5 ¼ x 5 ¼ po / in 133,35 x 133,35 mm	3 7/8 x 3 7/8 x po / in 98,4 x 98,4 mm
	7657	2 7/8 po / in 73,03 mm	6 1/2 x 6 1/2 po / in 165,1 x 165,1 mm	5 1/8 x 5 1/8 po / in 130,18 x 130,18 mm

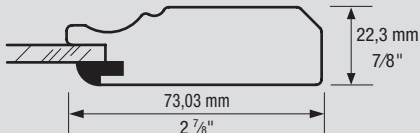

	# MODÈLE / MODEL	TYPE DE MODÈLE / TYPE OF MODEL	BATTANT / RAIL	DIMENSIONS MINIMALES / MINIMUM DIMENSIONS (Hauteur x Largeur / Height x Width)	MESURES POUR INSERTIONS DE VERRE / SIZES FOR GLASS INSERTS (Hauteur x Largeur / Height x Width)
ONYX 45°	8154	Verrière Frame door	Battant / Rail : 2 ¼ po / in	5 ¼ x 5 ¼ po / in 133,35 x 133,35 mm	3 7/8 x 3 7/8 x po / in 98,4 x 98,4 mm
RUBY 45°	8754	Verrière Frame door	Battant / Rail : 2 ¼ po / in	5 ¼ x 5 ¼ po / in 133,35 x 133,35 mm	3 7/8 x 3 7/8 x po / in 98,4 x 98,4 mm
AZUR 45°	8954	Verrière Frame door	Battant / Rail : 2 ¼ po / in	5 ¼ x 5 ¼ po / in 133,35 x 133,35 mm	3 5/8 x 3 5/8 po / in 92,08 x 92,08 mm
SAPHIR	8854	Verrière Frame door	Battant / Rail : 2 ¼ po / in	5 ¼ x 5 ¼ po / in 133,35 x 133,35 mm	3 7/8 x 3 7/8 x po / in 98,4 x 98,4 mm
ONYX 90°	9154	Verrière Frame door	Battant / Rail : 2 ¼ po / in	5 ¼ x 6 1/2 po / in 133,35 x 165,10 mm	3 3/4 x 3 13/16 po / in 95,25 x 96,84 mm
RUBY 90°	9754	Verrière Frame door	Battant / Rail : 2 ¼ po / in	5 ¼ x 6 1/2 po / in 133,35 x 165,10 mm	3 9/16 x 3 7/8 po / in 90,49 x 98,4 mm
AZUR 90°	9954	Verrière Frame door	Battant / Rail : 2 ¼ po / in	5 ¼ x 6 1/2 po / in 133,35 x 165,10 mm	3 9/16 x 3 9/16 po / in 90,49 x 90,49 mm

MOULURES ET ACCESSOIRES

MOULDINGS AND ACCESSORIES



7432
Cache-néon réversible /
Reversible light valance
Longueur / Length: 9 pi/ft

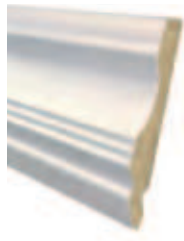
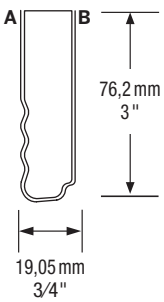

7443
Moulure de tête / Crown moulding
Longueur / Length: 9 pi/ft

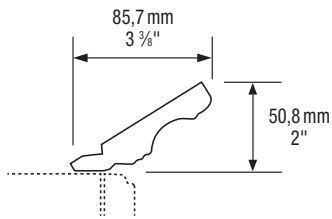

7445
Moulure de tête /
Crown moulding
Longueur / Length: 8 pi/ft

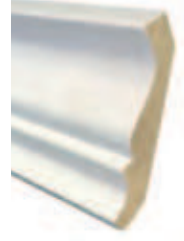
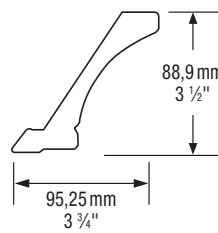

7446
O'Gee
Longueur / Length: 9 pi/ft



TABLEAU DE CONCORDANCE DES COULEURS

# couleurs / Colors #	Fournisseur / Supplier	Numéro de moulure / Moulding number																
		4022	4766	5027	7432	7443	7445	7446	9410	9414	9415	9432	9433	9443	9446	9447	9717	WP22
COLLECTION AVANTI ET MÉLAMINE / AVANTI AND MELAMINE COLLECTION																		
113	Uniboard	•	•	•														•
555	Uniboard	Aucune moulure disponible / No moulding available																
H50	Uniboard	•	•	•														•
H53	Uniboard	•	•	•														•
H54	Uniboard	•	•	•														•
H55	Uniboard	•	•	•														•
H70	Uniboard	•	•	•														•
H75	Uniboard	•	•	•														•
K01	Uniboard	•	•	•														•
K02	Uniboard	•	•	•														•
K06	Uniboard	•	•	•														•
K13	Uniboard	•	•	•														•
K14	Uniboard	•	•	•														•
K15	Uniboard	•	•	•														•
K16	Uniboard	•	•	•														•
K17	Uniboard	•	•	•														•
K23	Uniboard	•	•	•														•
K24	Uniboard	•	•	•														•
K45	Uniboard	•	•	•														•
K60	Uniboard	•	•	•														•
K62	Uniboard	•	•	•														•
K63	Uniboard	•	•	•														•
K64	Uniboard	•	•	•														•
K65	Uniboard	•	•	•														•
K66	Uniboard	•	•	•														•
K67	Uniboard	•	•	•														•
K71	Uniboard	•	•	•														•
K82	Uniboard																	
K83	Uniboard																	
K84	Uniboard																	
K88	Uniboard				•	•	•	•										
K95	Uniboard				•	•	•	•										
L004	Uniboard	•	•	•														•
L005	Uniboard				•	•		•										
L009	Uniboard				•	•		•										
L100	Tafisa	•	•	•														•
L105	Tafisa	•	•	•														•
L204	Tafisa	•	•	•														•
L444	Tafisa	•	•	•														•
L492	Tafisa	•	•	•														•
L493	Tafisa	•	•	•														•
L495	Tafisa	•	•	•														•
L530	Tafisa	•	•	•														•
L532	Tafisa	•	•	•														•
L543	Tafisa	•	•	•														•
L580	Tafisa										•	•		•			•	
L581	Tafisa										•	•		•			•	
L582	Tafisa										•	•		•			•	
L583	Tafisa										•	•		•			•	
L584	Tafisa										•	•		•			•	
L585	Tafisa										•	•		•			•	
L586	Tafisa										•	•		•			•	
L587	Tafisa										•	•		•			•	
L588	Tafisa										•	•		•			•	
L589	Tafisa										•	•		•			•	
L590	Tafisa										•	•		•			•	
L591	Tafisa										•	•		•			•	

COMPATIBLE COLOR OPTIONS

# couleurs / Colors #	Fournisseur / Supplier	Numéro de moulure / Moulding number																
		4022	4766	5027	7432	7443	7445	7446	9410	9414	9415	9432	9433	9443	9446	9447	9717	WP22
L592	Tafisa											•	•		•		•	
L593	Tafisa											•	•		•		•	
L761	Tafisa	Aucune moulure disponible / No moulding available																
L763	Tafisa	Aucune moulure disponible / No moulding available																
L764	Tafisa	Aucune moulure disponible / No moulding available																
L768	Tafisa	•	•	•														•
L807	Tafisa	•	•	•														•
M2001	Tafisa	•	•	•														•
M2002	Tafisa	•	•	•														•
M2003	Tafisa	•	•	•														•
M2004	Tafisa	•	•	•														•
M2005	Tafisa	•	•	•														•
M2006	Tafisa	•	•	•														•
M2007	Tafisa	•	•	•														•
M2010	Tafisa	•	•	•														•
M2015	Tafisa	•	•	•														•
M2035	Tafisa	Aucune moulure disponible / No moulding available																
M2036	Tafisa	Aucune moulure disponible / No moulding available																
M2042	Tafisa	Aucune moulure disponible / No moulding available																
M2054	Tafisa	Aucune moulure disponible / No moulding available																
M2056	Tafisa	Aucune moulure disponible / No moulding available																
P207	Uniboard	•	•	•														•
P555	Uniboard	Aucune moulure disponible / No moulding available																
WF226	Arauco	•	•	•														•
WF340	Arauco	•	•	•														•
WF375	Arauco	•	•	•														•
WF392	Arauco	•	•	•														•
WF393	Arauco	•	•	•														•
WF394	Arauco	•	•	•														•
COLLECTION PURTFLEX / PURTFLEX COLLECTION																		
PTF10632SF	Merino				•	•		•	•	•	•	•	•	•	•	•	•	
PTF11682SF	Merino				•	•		•	•	•	•	•	•	•	•	•	•	
PTF14621SF	Merino				•	•		•	•	•	•	•	•	•	•	•	•	
PTF14675SF	Merino				•	•		•	•	•	•	•	•	•	•	•	•	
PTF14693SF	Merino				•	•		•	•	•	•	•	•	•	•	•	•	
PTF300	Uniboard				•	•		•	•	•	•	•	•	•	•	•	•	
PTF777	Uniboard				•	•		•	•	•	•	•	•	•	•	•	•	
PTF777B	Uniboard				•	•		•	•	•	•	•	•	•	•	•	•	
PTFS463	Panolam				•	•		•	•	•	•	•	•	•	•	•	•	
PTFW150GB	Panolam				•	•		•	•	•	•	•	•	•	•	•	•	
PTFW379GB	Panolam				•	•		•	•	•	•	•	•	•	•	•	•	
PTFWF011GB	Panolam				•	•		•	•	•	•	•	•	•	•	•	•	
PTFWF432	Arauco				•	•		•										
PTFWF433	Arauco				•	•		•										
PTFWF434	Arauco				•	•		•										
PTFWF435	Arauco				•	•		•										
PTFWF440	Arauco				•	•		•										
PTFWF441	Arauco				•	•		•										
PTFWF446	Arauco				•	•		•										
PTFWK024GB	Panolam				•	•		•	•	•	•	•	•	•	•	•	•	
PTFWZ049GB	Panolam				•	•		•	•	•	•	•	•	•	•	•	•	
PTFWZ055GB	Panolam				•	•		•	•	•	•	•	•	•	•	•	•	
L580	Tafisa											•	•	•	•		•	
L581	Tafisa											•	•	•	•		•	
L582	Tafisa											•	•	•	•		•	
L583	Tafisa											•	•	•	•		•	
COLLECTION ÉVOLUTION POLYESTER/ EVOLUTION POLYESTER COLLECTION																		
WS503					•	•	•	•										

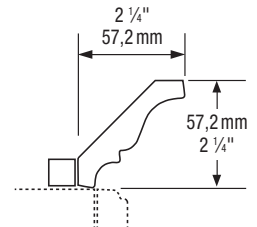
GARANTIE WARRANTY

5

ANS YEARS

1. CONDITIONS GÉNÉRALES

PRÉMOULÉ garantit ses produits distribués et vendus par un distributeur autorisé.

L'installation devrait toujours être effectuée par des professionnels qualifiés. Il est de la responsabilité de la personne installant le produit de déterminer s'il est approprié quant à une application particulière.

PRÉMOULÉ garantit la qualité du produit contre tout vice apparent ou caché qui affecterait sa qualité ou entraînerait sa détérioration prématurément selon les conditions suivantes :

2. DURÉE

La présente garantie est valable pour une période de 5 ans à partir de la date d'achat.

3. EXCLUSIONS

Cette garantie ne s'applique pas :

3.1 Lorsque les dommages sont causés :

- Par une mauvaise utilisation ou un emploi abusif du produit par l'acheteur;
- Par une installation inadéquate ou à l'extérieur d'une résidence;
- Par une modification, transformation, altération ou correction du produit sans le consentement écrit de PRÉMOULÉ;
- Par un entreposage inapproprié;
- Par des inconvénients indirects (incluant les dommages incidentaux, spéciaux ou consécutifs);

3.2 À la détérioration du produit résultant d'une usure normale.

3.3 À tous les dommages et inconvénients indirects ou incidents reliés aux coûts d'installation, de transport ou autres, relatives à l'application de la présente garantie.

3.4 Le nombre de pentures requises n'est pas respecté (voir p.16).

4. PORTÉE

La présente garantie est non accessible et constitue la seule garantie offerte par PRÉMOULÉ.

Il n'y a pas de garantie de valeur commerciale ou d'usage particulier, autre que la garantie détaillée ci-haut. PRÉMOULÉ n'émet aucune autre garantie d'aucune sorte, qu'elle soit explicite ou implicite, orale ou écrite.

5. EXÉCUTION DE LA GARANTIE

Pendant toute la durée de la présente garantie et pour les fins de s'en prévaloir, l'acheteur devra aviser rapidement le distributeur autorisé ou PRÉMOULÉ de toute défectuosité du produit en lui fournissant une preuve d'achat. L'acheteur ne pourra faire effectuer aucune réparation avant que le distributeur autorisé n'ait pu être en mesure d'examiner l'état du produit et de son installation.

Lorsque cette garantie est applicable, PRÉMOULÉ peut réparer les produits en cause, fournir des produits de remplacement ou à sa seule discrétion, offrir le remboursement du prix de vente.

6. DISTRIBUTEUR AUTORISÉ

Seul un distributeur autorisé de PRÉMOULÉ peut remplir les obligations de garantie contenues aux présentes, selon les termes et conditions des présentes, après avoir obtenu l'autorisation préalable de PRÉMOULÉ. Le distributeur autorisé n'est pas le mandataire de PRÉMOULÉ pour lui permettre de modifier ou d'étendre la portée de la présente garantie.

7. SPÉCIFICATIONS TECHNIQUES

Tolérance sur la hauteur et la largeur de +/- 1/32 po (0.8 mm);

- Toute porte de moins de 42 po de hauteur et 26 po de largeur est garantie contre un gauchissement de plus de 1/8 po/36 po.

Portes assemblées 45° / 90° de plus de 42 po :

- Sans traverse centrale : la garantie contre le gauchissement ne sera pas applicable.
- Avec traverse centrale : la garantie contre le gauchissement sera applicable.

1. GENERAL TERMS AND CONDITIONS

PRÉMOULÉ guarantees its products which are distributed and sold through an authorized distributor.

The installation should only be done by an experienced professional. It is also the responsibility of the person installing the product to determine its suitability for a particular application.

PRÉMOULÉ guarantees its products against any apparent or hidden defect that might affect their quality or cause premature deterioration. The following conditions apply:

2. DURATION

The guarantee is valid for a period of 5 years following the date of purchase.

3. EXCLUSIONS

This guarantee does not apply:

3.1 When damages are caused:

- By misuse or abuse of the product by the buyer;
- By improper installation or exposure to the elements;
- By any modification, transformation, or correction of the products without a written authorization from PRÉMOULÉ;
- By improper storage;
- By any indirect damage (including incidentals, special or consequential damages);

3.2 To any deterioration of the products resulting from normal wear and tear.

3.3 To any damage or incident relating to the costs of installation and transportation, or any other costs relative to the application of this guarantee.

3.4 The number of hinges required is not respected (see p.16).

4. SCOPE

This guarantee is unassignable and constitutes the only guarantee offered by PRÉMOULÉ. There is no guarantee of merchantability or fitness for specific purposes other than the guarantee detailed above. PRÉMOULÉ makes no other guarantee whatsoever, expressed or implied, oral or written.

5. EXECUTION OF GUARANTEE

For the duration of this guarantee, in order to exercise his rights, the buyer shall notify as soon as possible the authorized distributor or PRÉMOULÉ of any defect in the product and shall provide proof of purchase. The buyer shall not make any repairs before the authorized distributor has had an opportunity to examine the product and its installation.

When this guarantee is applicable, PRÉMOULÉ may repair its products, provide replacement or, at its sole option, offer the reimbursement of the purchase price.

6. AUTHORIZED DISTRIBUTOR

Only an authorized PRÉMOULÉ distributor may, in compliance with the terms and conditions of this guarantee, assume the obligations contained herein after obtaining prior authorization from PRÉMOULÉ. The authorized distributor is not mandated by PRÉMOULÉ to modify or extend the scope of this guarantee.

7. TECHNICAL SPECIFICATIONS

Height & width tolerance of 1/32 in (0.8 mm).

- Warp tolerance for doors of less than 42 in height and 26 in width is of 1/8 in/36 in.

Doors with 45° / 90° degree assembly over 42 in :

- Without middle cross-rail: will not carry any guarantee against warpage.
- With a middle crosspiece: will be guaranteed against warpage.

2375, avenue Dalton, bureau 200
Québec (Québec) Canada G1P 3S3

T 418 652-7777 | 1 866 652-7777

F 418 652-7558 | 1 866 652-7558

info@premoule.com

premoule.com

En raison du procédé d'impression, les photographies dans ce dépliant peuvent comporter des variations de couleur par rapport à nos couleurs réelles. Nous vous recommandons de vous procurer un échantillon pour plus d'exactitude.

Pictures in this brochure are for illustration purposes only. Actual color may vary slightly due to the printing process. For accurate color selection we recommend that you obtain a product sample.

Prémoulé appuie / Prémoulé supports

