

prēmoulē

V285WT
Jazz Silk
Textured

R105S - White - Super Matte

THERMOPLASTIC DOORS AND COMPONENTS

Custom program



TABLE OF CONTENTS

01 DISCOVER OUR THERMOPLASTIC DOOR OPTIONS

Door models

04 SHAKER

14 SLAB

16 STANDARD

30 SPECIAL

Customized touch

35 FRAME AND MULLION DOORS

37 PANELS, MOULDINGS AND ACCESSORIES

47 COLORS AND FINISHES

Information

45 TECHNICAL SPECIFICATIONS

53 WARRANTY



DISCOVER OUR THERMOPLASTIC DOOR OPTIONS

1. SELECT THE PRODUCT

2XXX = Door

4XXX = Standard frame and mullion doors

6XXX = Special frame and mullion doors

3XXX = Drawer front

5XXX = Panels, mouldings and accessories

2. SELECT THE DESIGN

1 Square

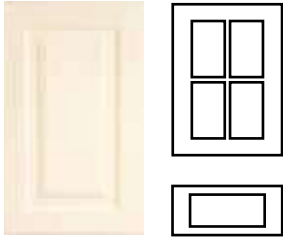

2 Arch

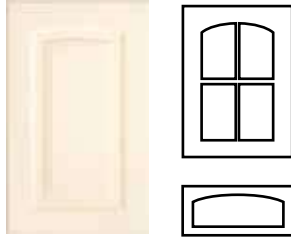

3 Cathedral

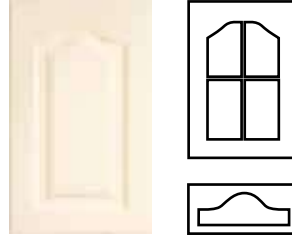

4 Half Circle

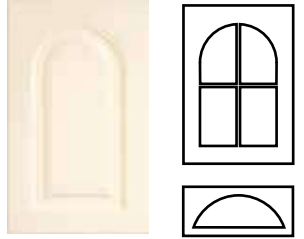

3. SELECT THE INTERIOR PROFILE



DISCOVER OUR THERMOPLASTIC DOOR OPTIONS

4. SELECT THE EXTERIOR PROFILE

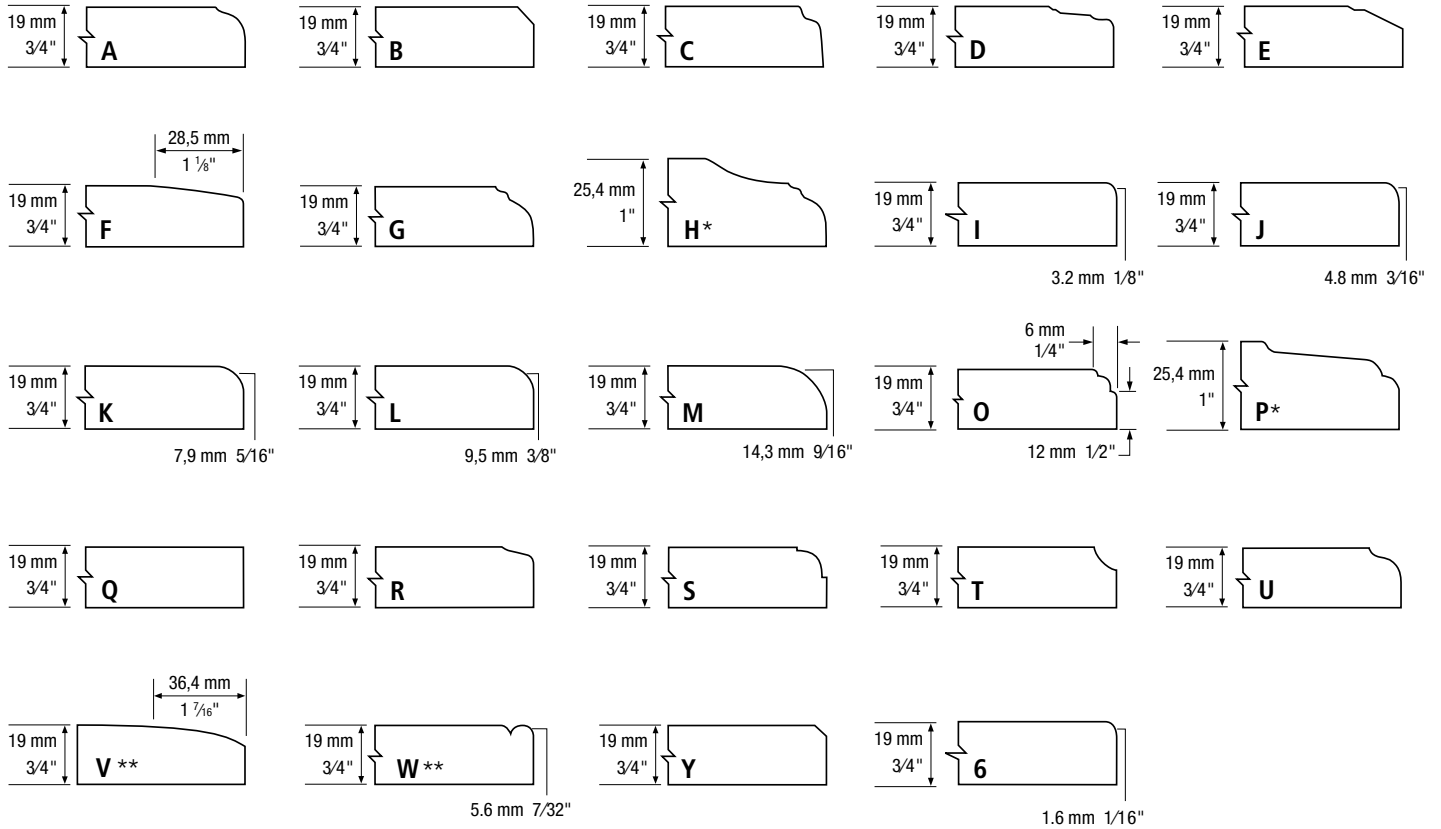

* Exterior profiles H and P available with MDF 1" only.

** Exterior profiles V and W available with an upcharge.

5. THE RESULT

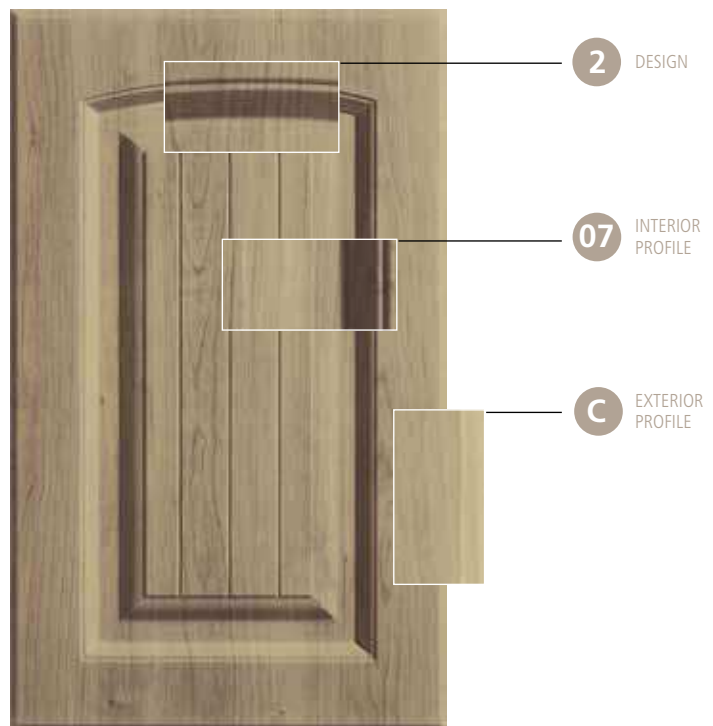

Model **2207**

Color: F435WT

Vertical grooves optional. Details on page 33.



R80S - CELESTINE - SATIN

DOOR MODELS

SHAKER
SLAB
STANDARD
SPECIAL

SHAKER MODELS

OPTION:

- See availability of same color melamine back, pages 47-48.

SERIES 41 Category 6



Model **2141**
Color: R82S

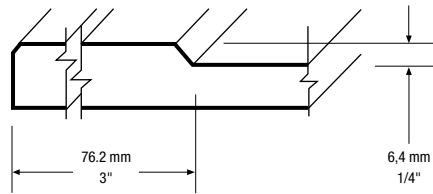

Model **3141**
Regular rails

Model **3141**
Reduced rails

Minimum dimensions

Doors and drawer fronts (Height x Width)

Model	mm	inches
2141/3141	177.8 x 177.8	7 x 7

Reduced rails drawer fronts (Height x Width)

Model	mm	inches
3141red	101.6 x 177.8	4 x 7

red = reduced rails

Default exterior profile: Y

Series 41 drawer fronts are manufactured with regular rails. If reduced rails drawer fronts are required, it must be specified when ordering.

SERIES 42 Category 6



Model **2142**
Color: A15WT

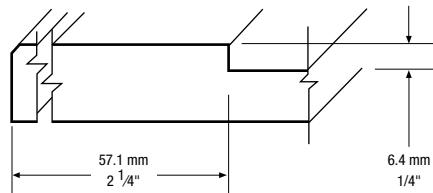

Model **3142**
Regular rails

Model **3142**
Reduced rails

Minimum dimensions

Doors and drawer fronts (Height x Width)

Model	mm	inches
2142/3142	139.7 x 139.7	5 1/2 x 5 1/2

Reduced rails drawer fronts (Height x Width)

Model	mm	inches
3142red	101.6 x 139.7	4 x 5 1/2

red = reduced rails

Default exterior profile: Y

Series 42 drawer fronts are manufactured with regular rails. If reduced rails drawer fronts are required, it must be specified when ordering.

STANDARD SPECIFICATIONS

- White melamine back
- The default woodgrain direction is vertical
- Shaker drawer fronts are manufactured with regular rails (unless reduced rails are specified)
- Maximum door height: 2438 mm (96"), maximum door width: 1193 mm (47")

SERIES 51 Cat. 6 / 55 Cat. 6



Model 2151
Color: A15WT

51 | Shaker style

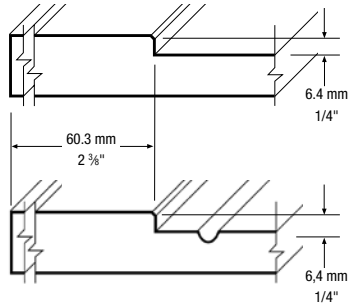

55 | Shaker style with grooves

The first groove starts at the center of the door



Model 3151
Regular rails

Model 3151
Reduced rails

Minimum dimensions

Doors and drawer fronts (Height x Width)

Model	mm	inches
2151/2155/3151/3155	146.0 x 146.0	5 3/4 x 5 3/4
2251/2255/3251/3255	161.0 x 146.0	6 11/32 x 5 3/4
2351/2355/3351/3355	186.0 x 200.6	7 11/32 x 7 29/32
2451/2455/3451/3455	((W±2) + 99.5) x 146.0	((W±2) + 3 15/16) x 5 3/4

Reduced rails drawer fronts (Height x Width)

Model	mm	inches
3151/3155red	76.2 x 146.0	3 x 5 3/4
3251/3255red	91.2 x 146.0	3 19/32 x 5 3/4
3351/3355red	116.2 x 200.6	4 9/16 x 7 7/8
3451/3455red	((W±2) + 29.7) x 146.0	((W±2) + 1 5/32) x 5 3/4

red = reduced rails / W = width
Default exterior profile: Y

Series 51 and 55 drawer fronts are manufactured with regular rails. If reduced rails drawer fronts are required, it must be specified when ordering.

Model 2155
Color: A15WT



55
Category 6

SERIES 52 Cat. 6 / 56 Cat. 6



Model 2152
Color: R82S

52 | Shaker style

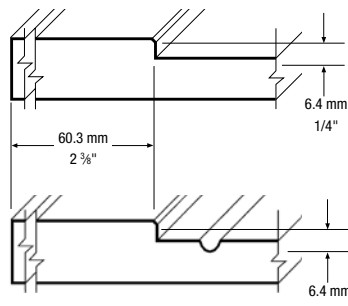

56 | Shaker style with grooves

The first groove starts at the center of the door



Model 3152
Regular rails

Model 3152
Reduced rails

Minimum dimensions

Doors and drawer fronts (Height x Width)

Model	mm	inches
2152/2156/3152/3156	146.0 x 146.0	5 3/4 x 5 3/4
2252/2256/3252/3256	161.0 x 146.0	6 11/32 x 5 3/4
2352/2356/3352/3356	186.0 x 200.6	7 11/32 x 7 7/8
2452/2456/3452/3456	((W±2) + 99.5) x 146.0	((W±2) + 3 29/32) x 5 3/4

Reduced rails drawer fronts (Height x Width)

Model	mm	inches
3152/3156red	76.2 x 146.0	3 x 5 3/4
3252/3256red	91.2 x 146.0	3 19/32 x 5 3/4
3352/3356red	116.2 x 200.6	4 9/16 x 7 7/8
3452/3456red	((W±2) + 29.7) x 146.0	((W±2) + 1 5/32) x 5 3/4

red = reduced rails / W = width
Default exterior profile: Y

Series 52 and 56 drawer fronts are manufactured with regular rails. If reduced rails drawer fronts are required, it must be specified when ordering.

Model 2156
Color: R82S



56
Category 6

SHAKER MODELS

OPTION:

- See availability of same color melamine back, pages 47-48.

SERIES 61 Cat. 6 / 65 Cat. 6



Model **2161**
Color: K85S

61 | Shaker style

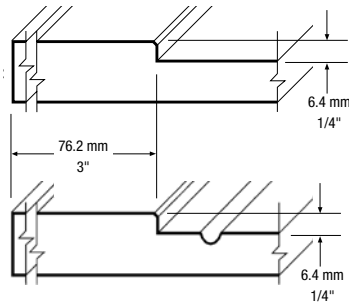

161/165



261/265



361/365



461/465

65 | Shaker style with grooves

The first groove starts at the center of the door



Model **3161**
Regular rails



Model **3161**
Reduced rails

Minimum dimensions

Doors and drawer fronts (Height x Width)

Model	mm	inches
2161/2165/3161/3165	177.8 x 177.8	7 x 7
2261/2265/3261/3265	192.8 x 177.8	7 19/32 x 7
2361/2365/3361/3365	217.8 x 232.4	8 19/32 x 9 5/32
2461/2465/3461/3465	$((W \div 2) + 115.4) \times 177.8$	$((W \div 2) + 4 9/16) \times 7$

Reduced rails drawer fronts (Height x Width)

Model	mm	inches
3161/3165red	76.2 x 177.8	3 x 7
3261/3265red	91.2 x 177.8	3 19/32 x 7
3361/3365red	116.2 x 232.4	4 19/32 x 9 5/32
3461/3465red	$((W \div 2) + 13.8) \times 177.8$	$((W \div 2) + 9/16) \times 7$

red = reduced rails / W = width
Default exterior profile: Y

Series 61 and 65 drawer fronts are manufactured with regular rails. If reduced rails drawer fronts are required, it must be specified when ordering.

Model **2165**
Color: K85S



65
Category 6

SERIES 62 Cat. 6 / 66 Cat. 6



Model **2162**
Color: V66WT

62 | Shaker style

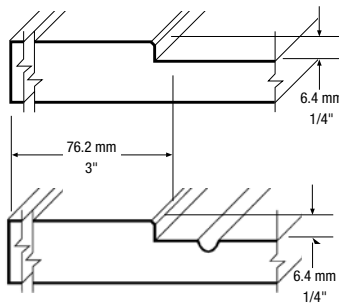

162/166



262/266



362/366

66 | Shaker style with grooves

The first groove starts at the center of the door



Model **3162**
Regular rails



Model **3162**
Reduced rails



462/466

Minimum dimensions

Doors and drawer fronts (Height x Width)

Model	mm	inches
2162/2166/3162/3166	177.8 x 177.8	7 x 7
2262/2266/3262/3266	192.8 x 177.8	7 19/32 x 7
2362/2366/3362/3366	217.8 x 232.4	8 19/32 x 9 5/32
2462/2466/3462/3466	$((W \div 2) + 115.4) \times 177.8$	$((W \div 2) + 4 9/16) \times 7$

Reduced rails drawer fronts (Height x Width)

Model	mm	inches
3162/3166red	76.2 x 177.8	3 x 7
3262/3266red	91.2 x 177.8	3 19/32 x 7
3362/3366red	116.2 x 232.4	4 19/32 x 9 5/32
3462/3466red	$((W \div 2) + 13.8) \times 177.8$	$((W \div 2) + 9/16) \times 7$

red = reduced rails / W = width
Default exterior profile: Y

Series 62 and 66 drawer fronts are manufactured with regular rails. If reduced rails drawer fronts are required, it must be specified when ordering.

Model **2166**
Color: V66WT



66
Category 6

STANDARD SPECIFICATIONS

- White melamine back
- The default woodgrain direction is vertical

- Shaker drawer fronts are manufactured with regular rails (unless reduced rails are specified)
- Maximum door height: 2438 mm (96"), maximum door width: 1193 mm (47")

SERIES 70 Category 6



Model **2170**
Color: V66WT

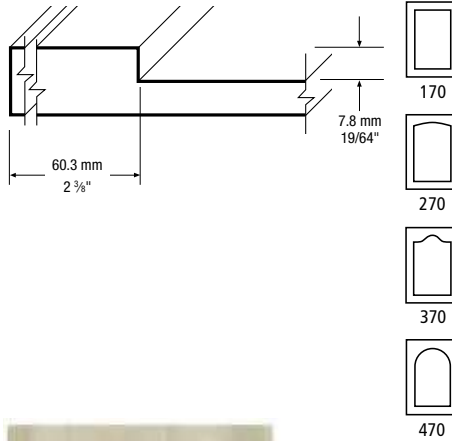

Model **3170**
Regular rails

Model **3170**
Reduced rails

Minimum dimensions

Doors and drawer fronts (Height x Width)

Model	mm	inches
2170/3170	146.0 x 146.0	5 3/4 x 5 3/4
2270/3170	161.0 x 146.0	6 11/32 x 5 3/4
2370/3370	186.0 x 200.6	7 11/32 x 7 29/32
2470/3470	$((W \div 2) + 99.5) \times 146.0$	$((W \div 2) + 3 31/32) \times 5 3/4$

Reduced rails drawer fronts (Height x Width)

Model	mm	inches
3170red	76.2 x 146.0	3 x 5 3/4
3270red	91.2 x 146.0	3 19/32 x 5 3/4
3370red	116.2 x 200.6	4 9/16 x 7 7/8
3470red	$((W \div 2) + 29.7) \times 146.0$	$((W \div 2) + 1 11/64) \times 5 3/4$

red = reduced rails / W = width
Default exterior profile: B

Series 70 drawer fronts are manufactured with regular rails. If reduced rails drawer fronts are required, it must be specified when ordering.

SERIES 71 Category 6



Model **2171**
Color: K85S

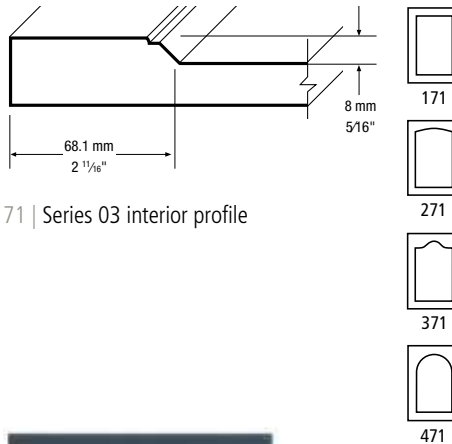

71 | Series 03 interior profile



Model **3171**
Regular rails

Model **3171**
Reduced rails

Minimum dimensions

Doors and drawer fronts (Height x Width)

Model	mm	inches
2171/3171	161.6 x 161.6	6 3/8 x 6 3/8
2271/3271	176.6 x 161.6	6 31/32 x 6 3/8
2371/3371	201.6 x 201.8	7 15/16 x 7 31/32
2471/3471	$((W \div 2) + 82.5) \times 161.6$	$((W \div 2) + 3 1/4) \times 6 3/8$

Reduced rails drawer fronts (Height x Width)

Model	mm	inches
3171red	102.0 x 161.6	4 1/64 x 6 3/8
3271red	117.0 x 161.6	4 39/64 x 6 3/8
3371red	142.0 x 201.8	5 19/32 x 7 31/32
3471red	$((W \div 2) + 22.9) \times 161.6$	$((W \div 2) + 29/32) \times 6 3/8$

red = reduced rails / W = width
Default exterior profile: B

Series 71 drawer fronts are manufactured with regular rails. If reduced rails drawer fronts are required, it must be specified when ordering.

SHAKER MODELS

OPTION:

- See availability of same color melamine back, pages 47-48.

SERIES 72 Category 6



Model **2172**
Color: A661S

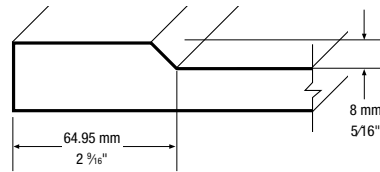

72 | Series 09 interior profile



Model **3172**
Regular rails

Model **3172**
Reduced rails

Minimum dimensions

Doors and drawer fronts (Height x Width)

Model	mm	inches
2172/3172	155.3 x 155.3	6 1/8 x 6 1/8
2272/3272	170.3 x 155.3	6 23/32 x 6 1/8
2372/3372	195.3 x 193.9	7 23/32 x 7 21/32
2472/3472	$((W \div 2) + 79.8) \times 155.3$	$((W \div 2) + 3 1/8) \times 6 1/8$

Reduced rails drawer fronts (Height x Width)

Model	mm	inches
3172red	91.3 x 155.3	3 5/8 x 6 1/8
3272red	106.3 x 155.3	4 3/16 x 6 1/8
3372red	131.3 x 193.9	5 3/16 x 7 21/32
3472red	$((W \div 2) + 15.4) \times 155.3$	$((W \div 2) + 39/64) \times 6 1/8$

red = reduced rails / W = width
Default exterior profile: B

Series 72 drawer front are manufactured with regular rails. If reduced rails drawer fronts are required, it must be specified when ordering.

SERIES 77 Category 6



Model **2177**
Color: A4WT

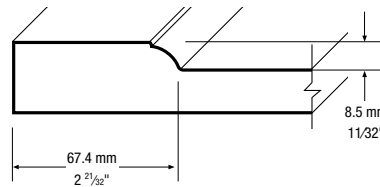

77 | Series 83 interior profile



Model **3177**
Regular rails

Model **3177**
Reduced rails

Minimum dimensions

Doors and drawer fronts (Height x Width)

Model	mm	inches
2177/3177	179.8 x 179.8	7 3/32 x 7 3/32
2277/3277	194.8 x 179.8	7 11/16 x 7 3/32
2377/3377	219.8 x 214.8	8 21/32 x 8 15/32
2477/3477	$((W \div 2) + 112.5) \times 179.8$	$((W \div 2) + 4 7/16) \times 7 3/32$

Reduced rails drawer fronts (Height x Width)

Model	mm	inches
3177red	116.6 x 179.8	4 19/32 x 7 3/32
3277red	131.6 x 179.8	5 3/16 x 7 3/32
3377red	156.6 x 214.8	6 3/16 x 8 15/32
3477red	$((W \div 2) + 49.3) \times 179.8$	$((W \div 2) + 1 31/32) \times 7 3/32$

red = reduced rails / W = width
Default exterior profile: C

Series 77 drawer front are manufactured with regular rails. If reduced rails drawer fronts are required, it must be specified when ordering.

STANDARD SPECIFICATIONS

- White melamine back
- The default woodgrain direction is vertical

- Shaker drawer fronts are manufactured with regular rails (unless reduced rails are specified)
- Maximum door height: 2438 mm (96"), maximum door width: 1193 mm (47")

SERIES 78 Category 6



Model **2178**
Color: A4WT

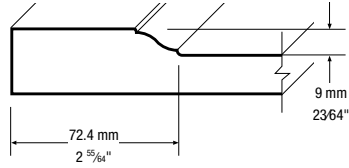

78 | Series 85 interior profile



Model **3178**
Regular rails

Model **3178**
Reduced rails



Minimum dimensions

Doors and drawer fronts (Height x Width)

Model	mm	inches
2178/3178	189.8 x 189.8	7 1/2 x 7 1/2
2278/3278	204.8 x 189.8	8 3/32 x 7 1/2
2378/3378	229.8 x 224.8	9 1/16 x 8 7/8
2478/3478	$((W \div 2) + 117.5) \times 189.8$	$((W \div 2) + 4 \frac{21}{32}) \times 7 \frac{1}{2}$

Reduced rails drawer fronts (Height x Width)

Model	mm	inches
3178red	126.6 x 189.8	5 x 7 1/2
3278red	141.6 x 189.8	5 19/32 x 7 1/2
3378red	166.6 x 224.8	6 9/16 x 8 7/8
3478red	$((W \div 2) + 54.3) \times 189.8$	$((W \div 2) + 2 \frac{5}{32}) \times 7 \frac{1}{2}$

red = reduced rails / W = width
Default exterior profile: C

Series 78 drawer fronts are manufactured with regular rails. If reduced rails drawer fronts are required, it must be specified when ordering.

SERIES 79 Category 6



Model **2179**
Color: A661S

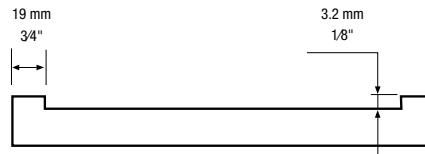

Model **3179**
Regular rails

Minimum dimensions

Doors and drawer fronts (Height x Width)

Model	mm	inches
2179/3179	76.2 x 76.2	3 x 3

W = width
Default exterior profile: Y

Series 79 drawer fronts are manufactured with regular rails. Frame and mullion doors not available in this model. Available exterior profiles: I, J, Q, Y and 6.

SHAKER MODELS

OPTION:

- See availability of same color melamine back, pages 47-48.

SERIES 80 Category 6



Model **2180**
Color: K464WT

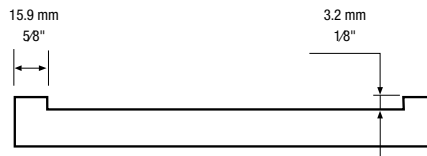

Model **3180**
Regular rails

Minimum dimensions

Doors and drawer fronts (Height x Width)

Model	mm	inches
2180/3180	76.2 x 76.2	3 x 3

W = width

Default exterior profile: Y

Series 80 drawer fronts are manufactured with regular rails. Frame and mullion doors not available in this model. Available exterior profiles: I, J, Q, Y and 6.

SERIES 942 Category 6



Model **2942**
Color: K257S

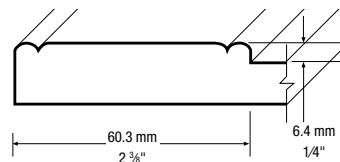

Model **3942**
Regular rails



Model **3942**
Reduced rails

Minimum dimensions

Doors and drawer fronts (Height x Width)

Model	mm	inches
2942/3942	146.0 x 146.0	5 3/4 x 5 3/4

Reduced rails drawer fronts (Height x Width)

Model	mm	inches
3942red	76.2 x 146.0	3 x 5 3/4

red = reduced rails

Default exterior profile: W

Series 942 drawer fronts are manufactured with regular rails. If reduced rails drawer fronts are required, it must be specified when ordering.

STANDARD SPECIFICATIONS

- White melamine back
- The default woodgrain direction is vertical
- Shaker drawer fronts are manufactured with regular rails (unless reduced rails are specified)
- Maximum door height: 2438 mm (96"), maximum door width: 1193 mm (47")

SERIES 64 Category 4



Model **2164**
Color: K257S

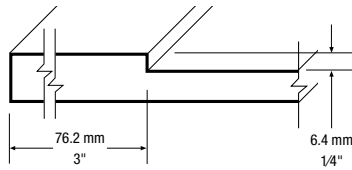

Model **3164**
Regular rails



Model **3164**
Reduced rails

Minimum dimensions

Doors and drawer fronts (Height x Width)

Model	mm	inches
2164/3164	177.8 x 177.8	7 x 7

Reduced rails drawer fronts (Height x Width)

Model	mm	inches
3164red	76.2 x 177.8	3 x 7

red = reduced rails

Default exterior profile: Y

Series 64 drawer fronts are manufactured with regular rails. If reduced rails drawer fronts are required, it must be specified when ordering.

SERIES 67 Category 4



Model **2167**
Color: K464WT

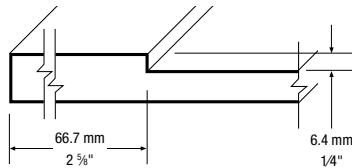

Model **3167**
Regular rails



Model **3167**
Reduced rails

Minimum dimensions

Doors and drawer fronts (Height x Width)

Model	mm	inches
2167/3167	158.8 x 158.8	6 1/4 x 6 1/4

Reduced rails drawer fronts (Height x Width)

Model	mm	inches
3167red	76.2 x 158.8	3 x 6 1/4

red = reduced rails

Default exterior profile: Y

Series 67 drawer fronts are manufactured with regular rails. If reduced rails drawer fronts are required, it must be specified when ordering.

SHAKER MODELS

OPTION:

- See availability of same color melamine back, pages 47-48.

SERIES 764 Category 5



Model **2764**
Color: R82S

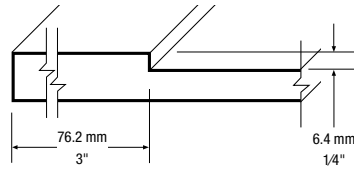

Model **3764**
Regular rails



Model **3764**
Reduced rails

Minimum dimensions

Doors and drawer fronts (Height x Width)

Model	mm	inches
2764/3764	177.8 x 177.8	7 x 7

Reduced rails drawer fronts (Height x Width)

Model	mm	inches
3764red	76.2 x 177.8	3 x 7

red = reduced rails

Default exterior profile: Y

Series 764 drawer fronts are manufactured with regular rails. If reduced rails drawer fronts are required, it must be specify when ordering.

SERIES 767 Category 5



Model **2767**
Color: A15WT

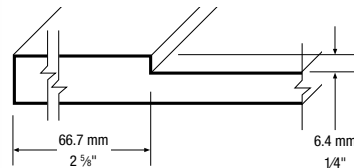

Model **3767**
Regular rails



Model **3767**
Reduced rails

Minimum dimensions

Doors and drawer fronts (Height x Width)

Model	mm	inches
2767/3767	158.8 x 158.8	6 1/4 x 6 1/4

Reduced rails drawer fronts (Height x Width)

Model	mm	inches
3767red	76.2 x 158.8	3 x 6 1/4

red = reduced rails

Default exterior profile: Y

Series 767 drawer fronts are manufactured with regular rails. If reduced rails drawer fronts are required, it must be specify when ordering.

STANDARD SPECIFICATIONS

- White melamine back
- The default woodgrain direction is vertical
- Shaker drawer fronts are manufactured with regular rails (unless reduced rails are specified)
- Maximum door height: 2438 mm (96"), maximum door width: 1193 mm (47")

SERIES 945 Category 7



Model **2945**
Color : A15WT

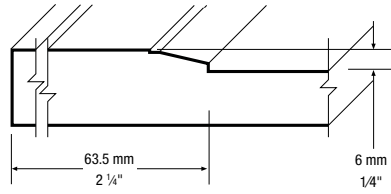

Model **3945**
Regular rails



Model **3945**
Reduced rails

Minimum dimensions

Doors and drawer fronts (Height x Width)

Model	mm	inches
2945/3945	152.4 x 152.4	6 x 6

Reduced rails drawer fronts (Height x Width)

Model	mm	inches
2945red	101.6 x 152.4	4 x 6

red = reduced rails
Default exterior profile: Y

Series 945 drawer fronts are manufactured with regular rails. If reduced rails drawer fronts are required, it must be specify when ordering.



C35S - White - Satin

SLAB MODELS

OPTION:

- See availability of same color melamine back, pages 47-48.

SERIES 00 Category 1



Model **2000**
Color: K85S

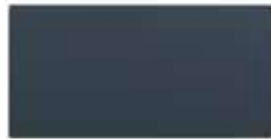
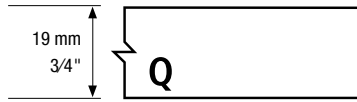

Model **3000**

Minimum dimensions for series 00 vary according to the exterior profile selected:

Doors and drawer fronts (Height x Width)

Model	Exterior profile	mm	inches
2000/3000	A, B, C, G, I, J, K, L, M, O, Q, R, S, T, U, V, Y, 6	38.1 x 38.1	1 1/2 x 1 1/2
2000/3000	D, E, W	50.8 x 50.8	2 x 2
2000/3000	F	76.2 x 76.2	3 x 3
2000/3000	H	82.6 x 82.6	3 1/4 x 3 1/4
2000/3000	P	90.5 x 90.5	3 9/16 x 3 9/16

Minimum charge of 0.19 sq.m. (2 sq.ft.) for thermoplastic fillers whose height or width is less than 76.2 mm (3") and whose length is greater than 1828 mm (72").

Frame and mullion doors not available in this model.

SERIES 00 Category 1



Model **2000**
Color: V66WT

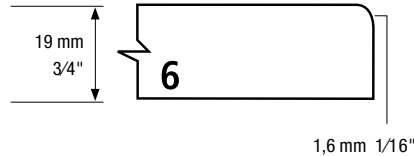

Model **3000**

Minimum dimensions for series 00 vary according to the exterior profile selected:

Doors and drawer fronts (Height x Width)

Model	Exterior profile	mm	inches
2000/3000	A, B, C, G, I, J, K, L, M, O, Q, R, S, T, U, V, Y, 6	38.1 x 38.1	1 1/2 x 1 1/2
2000/3000	D, E, W	50.8 x 50.8	2 x 2
2000/3000	F	76.2 x 76.2	3 x 3
2000/3000	H	82.6 x 82.6	3 1/4 x 3 1/4
2000/3000	P	90.5 x 90.5	3 9/16 x 3 9/16

Minimum charge of 0.19 sq.m. (2 sq.ft.) for thermoplastic fillers whose height or width is less than 76.2 mm (3") and whose length is greater than 1828 mm (72").

Frame and mullion doors not available in this model.

STANDARD FEATURES

- White melamine back
- The default woodgrain direction is vertical

- Maximum door height: 2438 mm (96")
- Maximum door width: 1193 mm (47")

SERIES 00 Category 1



Model **2000**
Color: V66WT

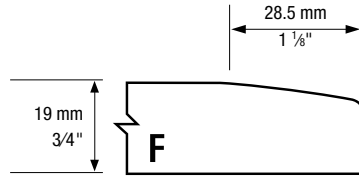

Model **3000**

Minimum dimensions for series 00 vary according to the exterior profile selected:

Doors and drawer fronts (Height x Width)

Model	Exterior profile	mm	inches
2000/3000	A, B, C, G, I, J, K, L, M, O, Q, R, S, T, U, V, Y, 6	38.1 x 38.1	1 1/2 x 1 1/2
2000/3000	D, E, W	50.8 x 50.8	2 x 2
2000/3000	F	76.2 x 76.2	3 x 3
2000/3000	H	82.6 x 82.6	3 1/4 x 3 1/4
2000/3000	P	90.5 x 90.5	3 9/16 x 3 9/16

Minimum charge of 0.19 sq.m. (2 sq.ft.) for thermoplastic fillers whose height or width is less than 76.2 mm (3") and whose length is greater than 1828 mm (72").

Frame and mullion doors not available in this model.

SERIES 00 Category 2



Model **2000**
Color: K85S

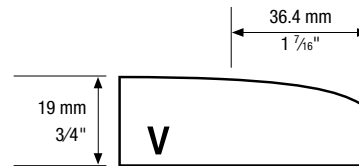

Model **3000**

Minimum dimensions for series 00 vary according to the exterior profile selected:

Doors and drawer fronts (Height x Width)

Model	Exterior profile	mm	inches
2000/3000	A, B, C, G, I, J, K, L, M, O, Q, R, S, T, U, V, Y, 6	38.1 x 38.1	1 1/2 x 1 1/2
2000/3000	D, E, W	50.8 x 50.8	2 x 2
2000/3000	F	76.2 x 76.2	3 x 3
2000/3000	H	82.6 x 82.6	3 1/4 x 3 1/4
2000/3000	P	90.5 x 90.5	3 9/16 x 3 9/16

Minimum charge of 0.19 sq.m. (2 sq.ft.) for thermoplastic fillers whose height or width is less than 76.2 mm (3") and whose length is greater than 1828 mm (72").

Frame and mullion doors not available in this model.

STANDARD MODELS

OPTIONS:

- See availability of same color melamine back, pages 47-48.
- For regular rails drawer fronts, order as a door.

SERIES 03 Category 4



Model **2103**
Color: A661S

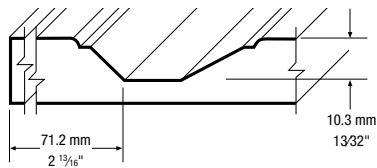

Model **3103**
Standard models

Minimum dimensions

Doors (Height x Width)

Model	mm	inches
2103	225.0 x 225.0	8 7/8 x 8 7/8
2203	240.0 x 225.0	9 15/32 x 8 7/8
2303	265.0 x 225.0	10 7/16 x 8 7/8
2403	$((W \div 2) + 82.5) \times 225.0$	$((W \div 2) + 3 1/4) \times 8 7/8$

Drawer fronts (Height x Width)

Model	mm	inches
3103	146.4 x 225.0	5 25/32 x 8 7/8
3203	161.4 x 225.0	6 3/8 x 8 7/8
3303	186.4 x 225.0	7 11/32 x 8 7/8
3403	$((W \div 2) + 3.9) \times 225.0$	$((W \div 2) + 5/32) \times 8 7/8$

W = width
Default exterior profile: B

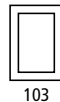

SERIES 27 Category 4



Model **2127**
Color: A4WT

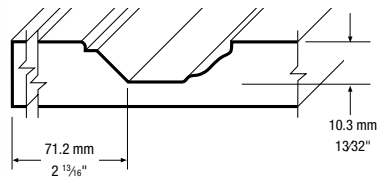

Model **3127**
Reduced rails

Minimum dimensions

Doors (Height x Width)

Model	mm	inches
2127	208.4 x 208.4	8 2/32 x 8 2/32
2227	223.4 x 208.4	8 13/16 x 8 2/32
2327	248.4 x 208.4	9 25/32 x 8 2/32
2427	$((W \div 2) + 81.2) \times 208.4$	$((W \div 2) + 3 7/32) \times 8 2/32$

Drawer fronts (Height x Width)

Model	mm	inches
3127	129.8 x 208.4	5 1/8 x 8 2/32
3227	144.8 x 208.4	5 23/32 x 8 2/32
3327	169.8 x 208.4	6 11/16 x 8 2/32
3427	$((W \div 2) + 2.6) \times 208.4$	$((W \div 2) + 1/8) \times 8 2/32$

W = width
Default exterior profile: A



STANDARD SPECIFICATIONS

- White melamine back
- The default woodgrain direction is vertical

- Drawer fronts are manufactured with reduced rails (unless regular rails are specified)
- Maximum door height: 2438 mm (96"), maximum door width: 1193 mm (47")

SERIES 49 Category 4



Model **2149**
Color: A4WT

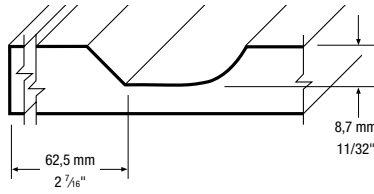

149



249



349



449

Minimum dimensions

Doors (Height x Width)

Model	mm	inches
2149	195.6 x 195.6	7 ²³ / ₃₂ x 7 ²³ / ₃₂
2249	210.6 x 195.6	8 ⁵ / ₁₆ x 7 ²³ / ₃₂
2349	238.6 x 220.0	9 ¹³ / ₃₂ x 8 ¹¹ / ₁₆
2449	((W÷2) + 77) x 195.6	((W÷2) + 3 ¹ / ₁₆) x 7 ²³ / ₃₂

Drawer fronts (Height x Width)

Model	mm	inches
3149	139.6 x 195.6	5 ¹ / ₂ x 7 ²³ / ₃₂
3249	154.6 x 195.6	6 ³ / ₃₂ x 7 ²³ / ₃₂
3349	185.6 x 220.0	7 ⁵ / ₁₆ x 8 ¹¹ / ₁₆
3449	((W÷2) + 21) x 195.6	((W÷2) + ²⁷ / ₃₂) x 7 ²³ / ₃₂

W = width
Default exterior profile: C



Model **3149**
Reduced rails

SERIES 50 Cat. 2 / 40 Cat. 2



Model **2150**
Color: A661S

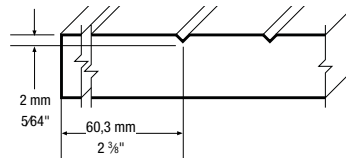

50 | Standard style with grooves

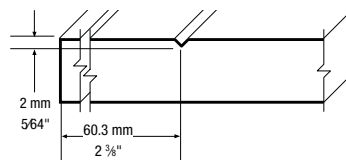

40 | Standard style



150



250



350



450



Model **3150**
Regular rails



Model **3150**
Reduced rails

Minimum dimensions

Doors and drawer fronts (Height x Width)

Model	mm	inches
2150/2140/3150/3140	146.0 x 146.0	5 ³ / ₄ x 5 ³ / ₄
2250/2240/3250/3240	161.0 x 146.0	6 ¹¹ / ₃₂ x 5 ³ / ₄
2350/2340/3350/3340	186.0 x 200.6	7 ¹¹ / ₃₂ x 7 ²⁹ / ₃₂
2450/2440/3450/3440	((W÷2) + 60.4) x 146.0	((W÷2) + 2 ¹³ / ₃₂) x 5 ³ / ₄

Reduced rails drawer fronts (Height x Width)

Model	mm	inches
3150/3140red	76.2 x 146.0	3 x 5 ³ / ₄
3250/3240red	91.2 x 146.0	3 ¹⁹ / ₃₂ x 5 ³ / ₄
3350/3340red	116.2 x 200.6	4 ¹⁹ / ₃₂ x 7 ²⁹ / ₃₂
3450/3440red	((W÷2) - 9.4) x 146.0	((W÷2) - ³ / ₈) x 5 ³ / ₄

Note: Not available with exterior profiles D, F, H, P, V and W.
red = reduced rails / W = width

Default exterior profile: Q

Series 40 and 50 drawer fronts are manufactured with regular rails.
If reduced rails drawer fronts are required, it must be specify when ordering.

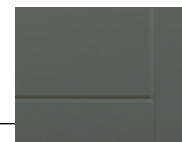

Model **2140**
Color: A661S

40

Category 2

STANDARD MODELS

OPTIONS:

- See availability of same color melamine back, pages 47-48.
- For regular rails drawer fronts, order as a door.

SERIES 73 Category 3



Model **2173**
Color: K464WT

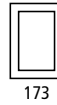
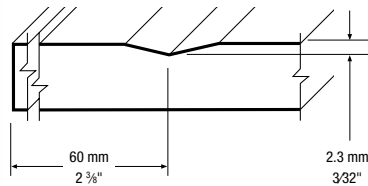

Model **3173**
Reduced rails

Minimum dimensions

Doors (Height x Width)

Model	mm	inches
2173	153.7 x 153.7	6 1/16 x 6 1/16
2273	168.7 x 153.7	6 21/32 x 6 1/16
2373	193.7 x 200.0	7 21/32 x 7 7/8
2473	$((W \div 2) + 60.1) \times 153.7$	$((W \div 2) + 2 \frac{3}{8}) \times 6 \frac{1}{16}$

Drawer fronts (Height x Width)

Model	mm	inches
3173	93.7 x 153.7	3 23/32 x 6 1/16
3273	108.7 x 153.7	4 9/32 x 6 1/16
3373	133.7 x 200.0	5 9/32 x 7 7/8
3473	$((W \div 2) + 0.1) \times 153.7$	$((W \div 2) + 1/32) \times 6 \frac{1}{16}$

W = width
Default exterior profile: B

SERIES 76 Category 4



Model **2176**
Color: K257S

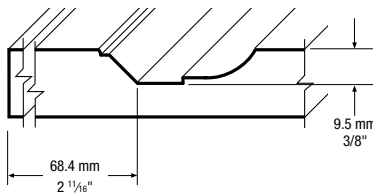

Model **3176**
Reduced rails

Minimum dimensions

Doors (Height x Width)

Model	mm	inches
2176	216.1 x 216.1	8 17/32 x 8 17/32
2276	231.1 x 216.1	9 1/8 x 8 17/32
2376	256.1 x 216.1	10 3/32 x 8 17/32
2476	$((W \div 2) + 87.7) \times 216.1$	$((W \div 2) + 3 \frac{15}{32}) \times 8 \frac{17}{32}$

Drawer fronts (Height x Width)

Model	mm	inches
3176	149.2 x 216.1	5 7/8 x 8 17/32
3276	164.2 x 216.1	6 15/32 x 8 17/32
3376	189.2 x 216.1	7 15/32 x 8 17/32
3476	$((W \div 2) + 20.9) \times 216.1$	$((W \div 2) + 27/32) \times 8 \frac{17}{32}$

W = width
Default exterior profile: B

STANDARD SPECIFICATIONS

- White melamine back
- The default woodgrain direction is vertical
- Drawer fronts are manufactured with reduced rails (unless regular rails are specified)
- Maximum door height: 2438 mm (96"), maximum door width: 1193 mm (47")

SERIES 83 Cat. 6 / 93 Cat. 5



Model **2183**
Color: K257S

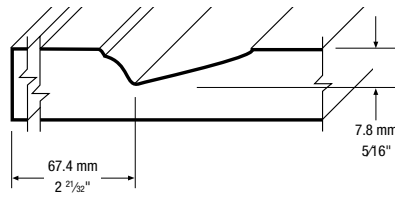

- 83 | Square and beveled corners
- 93 | Square interior profile as series 83, without beveled corners



Model **3183**
Reduced rails



183

193



283

293



383

393



483

493

Minimum dimensions

Doors (Height x Width)

Model	mm	inches
2183/2193	201.5 x 201.5	7 15/16 x 7 15/16
2283/2293	216.5 x 201.5	8 17/32 x 7 15/16
2383/2393	241.5 x 230.8	9 17/32 x 9 3/32
2483/2493	$((W \div 2) + 112.5) \times 201.5$	$((W \div 2) + 4 7/16) \times 7 15/16$

Drawer fronts (Height x Width)

Model	mm	inches
3183/3193	138.3 x 201.5	5 15/32 x 7 15/16
3283/3293	153.3 x 201.5	6 1/16 x 7 15/16
3383/3393	178.3 x 230.8	7 1/32 x 9 3/32
3483/3493	$((W \div 2) + 49.3) \times 201.5$	$((W \div 2) + 1 31/32) \times 7 15/16$

W = width

Default exterior profile: C

Model **2193**
Color: K257S



93

Category 5

SERIES 85 Cat. 6 / 95 Cat. 5



Model **2185**
Color: K464WT

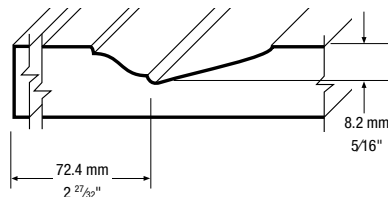

- 85 | Square and beveled corners
- 95 | Square interior profile as series 85, without beveled corners



Model **3185**
Reduced rails



185

195



285

295



385

395



485

495

Minimum dimensions

Doors (Height x Width)

Model	mm	inches
2185/2195	212.4 x 212.4	8 3/8 x 8 3/8
2285/2295	227.4 x 212.4	8 31/32 x 8 3/8
2385/2395	252.4 x 250.8	9 15/16 x 9 7/8
2485/2495	$((W \div 2) + 117.5) \times 212.4$	$((W \div 2) + 4 21/32) \times 8 3/8$

Drawer fronts (Height x Width)

Model	mm	inches
3185/3195	149.2 x 212.4	5 7/8 x 8 3/8
3285/3295	164.2 x 212.4	6 15/32 x 8 3/8
3385/3395	189.2 x 250.8	7 15/32 x 9 7/8
3485/3495	$((W \div 2) + 54.3) \times 212.4$	$((W \div 2) + 2 5/32) \times 8 3/8$

W = width

Default exterior profile: C

Model **2195**
Color: K464WT



95

Category 5

STANDARD MODELS

OPTIONS:

- See availability of same color melamine back, pages 47-48.
- For regular rails drawer fronts, order as a door.

SERIES 86 Cat. 6 / 96 Cat. 5



Model **2186**
Color: R82S

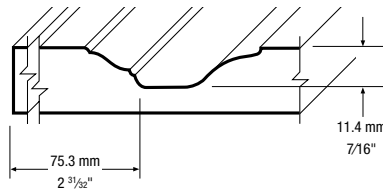

- 86 | Square and beveled corners
- 96 | Square interior profile as series 86, without beveled corners



186

196



286

296



386

396



486

496



Model **3186**
Reduced rails



Model **2196**
Color: R82S

96

Category 5

Minimum dimensions

Doors (Height x Width)

Model	mm	inches
2186/2196	237.4 x 237.4	9 3/8 x 9 3/8
2286/2296	252.4 x 237.4	9 15/16 x 9 3/8
2386/2396	277.4 x 250.8	10 15/16 x 9 7/8
2486/2496	$((W \div 2) + 117.5) \times 237.4$	$((W \div 2) + 4 21/32) \times 9 3/8$

Drawer fronts (Height x Width)

Model	mm	inches
3186/3196	174.2 x 237.4	6 7/8 x 9 3/8
3286/3296	189.2 x 237.4	7 15/32 x 9 3/8
3386/3396	214.2 x 250.8	8 7/16 x 9 7/8
3486/3496	$((W \div 2) + 54.3) \times 237.4$	$((W \div 2) + 2 5/32) \times 9 3/8$

W = width
Default exterior profile: C

SERIES 87 Cat. 6 / 97 Cat. 5



Model **2187**
Color: A15WT

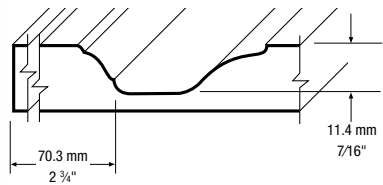

- 87 | Square and beveled corners
- 97 | Square interior profile as series 87, without beveled corners



187

197



287

297



387

397



487

497



Model **3187**
Reduced rails



Model **2197**
Color: A15WT

97

Category 5

Minimum dimensions

Doors (Height x Width)

Model	mm	inches
2187/2197	227.4 x 227.4	8 31/32 x 8 31/32
2287/2297	242.4 x 227.4	9 9/16 x 8 31/32
2387/2397	267.4 x 230.8	10 17/32 x 9 3/32
2487/2497	$((W \div 2) + 112.5) \times 227.4$	$((W \div 2) + 4 7/16) \times 8 31/32$

Drawer fronts (Height x Width)

Model	mm	inches
3187/3197	164.2 x 227.4	6 15/32 x 8 31/32
3287/3297	179.2 x 227.4	7 1/16 x 8 31/32
3387/3397	204.2 x 230.8	8 1/16 x 9 3/32
3487/3497	$((W \div 2) + 49.3) \times 227.4$	$((W \div 2) + 1 31/32) \times 8 31/32$

W = width
Default exterior profile: C

STANDARD SPECIFICATIONS

- White melamine back
- The default woodgrain direction is vertical
- Drawer fronts are manufactured with reduced rails (unless regular rails are specified)
- Maximum door height: 2438 mm (96"), maximum door width: 1193 mm (47")

SERIES 88 Cat. 6 / 98 Cat. 5



Model **2188**
Color: A15WT

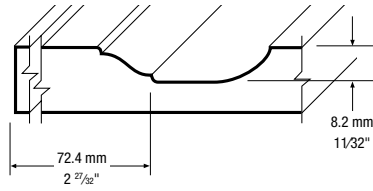

- 88 | Square and beveled corners
- 98 | Square interior profile as series 88, without beveled corners



188

198



288

298



388

398



488

498



Model **3188**
Reduced rails



Model **2198**
Color: A15WT

98

Category 5

Minimum dimensions

Doors (Height x Width)

Model	mm	inches
2188/2198	214.9 x 214.9	8 15/32 x 8 15/32
2288/2298	229.9 x 214.9	9 1/16 x 8 15/32
2388/2398	254.9 x 250.8	10 1/16 x 9 7/8
2488/2498	$((W \div 2) + 117.5) \times 214.9$	$((W \div 2) + 4 21/32) \times 8 15/32$

Drawer fronts (Height x Width)

Model	mm	inches
3188/3198	151.7 x 214.9	6 x 8 15/32
3288/3298	166.7 x 214.9	6 9/16 x 8 15/32
3388/3398	191.7 x 250.8	7 9/16 x 9 7/8
3488/3498	$((W \div 2) + 54.3) \times 214.9$	$((W \div 2) + 2 5/32) \times 8 15/32$

W = width

Default exterior profile: C

SERIES 89 Cat. 6 / 99 Cat. 5



Model **2189**
Color: R82S

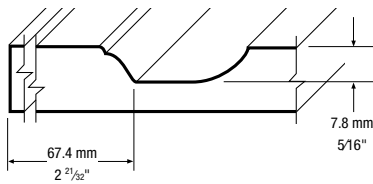

- 89 | Square and beveled corners
- 99 | Square interior profile as series 89, without beveled corners



189

199



289

299



389

399



489

499

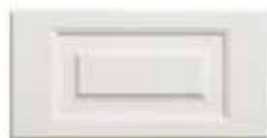

Model **3189**
Reduced rails



Model **2199**
Color: R82S

99

Category 5

Minimum dimensions

Doors (Height x Width)

Model	mm	inches
2189/2199	204.4 x 204.4	8 1/16 x 8 1/16
2289/2299	219.4 x 204.4	8 21/32 x 8 1/16
2389/2399	244.4 x 230.8	9 5/8 x 9 3/16
2489/2499	$((W \div 2) + 112.5) \times 204.4$	$((W \div 2) + 4 7/16) \times 8 1/16$

Drawer fronts (Height x Width)

Model	mm	inches
3189/3199	141.2 x 204.4	5 9/16 x 8 1/16
3289/3299	156.2 x 204.4	6 5/32 x 8 1/16
3389/3399	181.2 x 230.8	7 5/32 x 9 3/16
3489/3499	$((W \div 2) + 49.3) \times 204.4$	$((W \div 2) + 1 31/32) \times 8 1/16$

W = width

Default exterior profile: C

STANDARD MODELS

OPTIONS:

- See availability of same color melamine back, pages 47-48.
- For regular rails drawer fronts, order as a door.

SERIES 912 Category 3



Model **2912**
Color: K85S

R = 3 mm

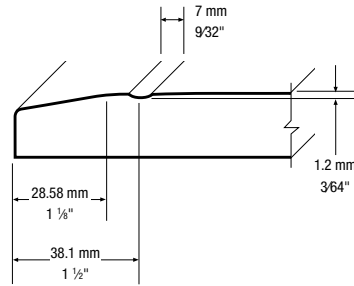

R = 3 mm

Model **3912**
Regular rails

Minimum dimensions

Doors (Height x Width)

Model	mm	inches
2912	95.9 x 95.9	3 ²⁵ / ₃₂ x 3 ²⁵ / ₃₂

Drawer fronts (Height x Width)

Model	mm	inches
3912	95.9 x 95.9	3 ²⁵ / ₃₂ x 3 ²⁵ / ₃₂

Default exterior profile: F

Model 912 drawer fronts are manufactured with regular rails.

SERIES 01 Category 2



Model **2101**
Color: V66WT

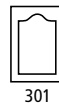
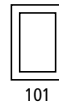
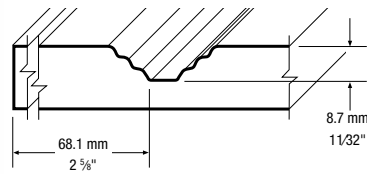

Model **3101**
Reduced rails

Minimum dimensions

Doors (Height x Width)

Model	mm	inches
2101	182.8 x 182.8	7 ⁷ / ₃₂ x 7 ⁷ / ₃₂
2201	201.3 x 182.8	7 ¹⁵ / ₁₆ x 7 ⁷ / ₃₂
2301	222.8 x 182.8	8 ²⁵ / ₃₂ x 7 ⁷ / ₃₂
2401	((W÷2) + 71.6) x 182.8	((W÷2) + 2 ²⁷ / ₃₂) x 7 ⁷ / ₃₂

Drawer fronts (Height x Width)

Model	mm	inches
3101	120.2 x 182.8	4 ³ / ₄ x 7 ⁷ / ₃₂
3201	138.7 x 182.8	5 ¹⁵ / ₃₂ x 7 ⁷ / ₃₂
3301	160.2 x 182.8	6 ⁵ / ₁₆ x 7 ⁷ / ₃₂
3401	((W÷2) + 9.0) x 182.8	((W÷2) + ³ / ₈) x 7 ⁷ / ₃₂

W = width

Default exterior profile: C

STANDARD SPECIFICATIONS

- White melamine back
- The default woodgrain direction is vertical

- Drawer fronts are manufactured with reduced rails (unless regular rails are specified)
- Maximum door height: 2438 mm (96"), maximum door width: 1193 mm (47")

SERIES 04 Category 2



Model **2104**
Color: V66WT

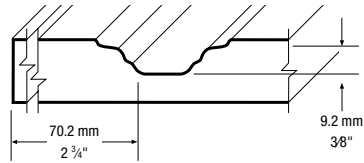

Model **3104**
Reduced rails

Minimum dimensions

Doors (Height x Width)

Model	mm	inches
2104	199.0 x 199.0	7 ²⁷ / ₃₂ x 7 ²⁷ / ₃₂
2204	214.0 x 199.0	8 ⁷ / ₁₆ x 7 ²⁷ / ₃₂
2304	239.0 x 199.0	9 ⁷ / ₁₆ x 7 ²⁷ / ₃₂
2404	((W÷2) + 75.1) x 199.0	((W÷2) + 2 ³¹ / ₃₂) x 7 ²⁷ / ₃₂

Drawer fronts (Height x Width)

Model	mm	inches
3104	136.4 x 199.0	5 ³ / ₈ x 7 ²⁷ / ₃₂
3204	151.4 x 199.0	5 ³¹ / ₃₂ x 7 ²⁷ / ₃₂
3304	179.4 x 199.0	7 ³ / ₃₂ x 7 ²⁷ / ₃₂
3404	((W÷2) + 12.5) x 199.0	((W÷2) + 1/2) x 7 ²⁷ / ₃₂

W = width
Default exterior profile: C

SERIES 06 Category 3



Model **2106**
Color: K85S

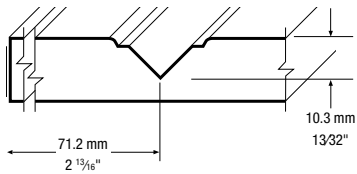

Model **3106**
Reduced rails

Minimum dimensions

Doors (Height x Width)

Model	mm	inches
2106	180.2 x 180.2	7 ¹ / ₈ x 7 ¹ / ₈
2206	195.2 x 180.2	7 ¹¹ / ₁₆ x 7 ¹ / ₈
2306	220.2 x 180.2	8 ¹¹ / ₁₆ x 7 ¹ / ₈
2406	((W÷2) + 81.5) x 180.2	((W÷2) + 3 ⁷ / ₃₂) x 7 ¹ / ₈

Drawer fronts (Height x Width)

Model	mm	inches
3106	101.6 x 180.2	4 x 7 ³ / ₃₂
3206	116.6 x 180.2	4 ¹⁹ / ₃₂ x 7 ³ / ₃₂
3306	141.6 x 180.2	5 ¹⁹ / ₃₂ x 7 ³ / ₃₂
3406	((W÷2) + 2.9) x 180.2	((W÷2) + 1/8) x 7 ³ / ₃₂

W = width
Default exterior profile: B

STANDARD MODELS

OPTIONS:

- See availability of same color melamine back, pages 47-48.
- For regular rails drawer fronts, order as a door.

SERIES 07 Category 5



Model **2107**
Color: A661S

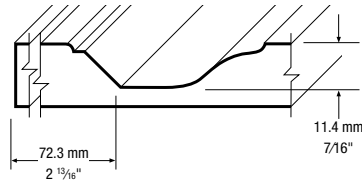

107



207



307



407



Model **3107**
Reduced rails

Minimum dimensions

Doors (Height x Width)

Model	mm	inches
2107	235.0 x 235.0	9 ⁹ / ₃₂ x 9 ⁹ / ₃₂
2207	250.0 x 235.0	9 ²⁷ / ₃₂ x 9 ⁹ / ₃₂
2307	275.0 x 235.0	10 ²⁷ / ₃₂ x 9 ⁹ / ₃₂
2407	((W÷2) + 86.8) x 235.0	((W÷2) + 3 ⁷ / ₁₆) x 9 ⁹ / ₃₂

Drawer fronts (Height x Width)

Model	mm	inches
3107	156.4 x 235.0	6 ³ / ₁₆ x 9 ⁹ / ₃₂
3207	171.4 x 235.0	6 ³ / ₄ x 9 ⁹ / ₃₂
3307	196.4 x 235.0	7 ³ / ₄ x 9 ⁹ / ₃₂
3407	((W÷2) + 8.2) x 235.0	((W÷2) + ¹¹ / ₃₂) x 9 ⁹ / ₃₂

W = width
Default exterior profile: B

SERIES 08 Category 3



Model **2108**
Color: A4WT

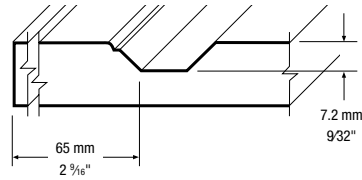

108



208



308



408



Model **3108**
Reduced rails

Minimum dimensions

Doors (Height x Width)

Model	mm	inches
2108	185.1 x 185.1	7 ⁵ / ₁₆ x 7 ⁵ / ₁₆
2208	200.1 x 185.1	7 ²⁹ / ₃₂ x 7 ⁵ / ₁₆
2308	225.1 x 185.1	8 ⁷ / ₈ x 7 ⁵ / ₁₆
2408	((W÷2) + 71.8) x 185.1	((W÷2) + 2 ²⁷ / ₃₂) x 7 ⁵ / ₁₆

Drawer fronts (Height x Width)

Model	mm	inches
3108	120.5 x 185.1	4 ³ / ₄ x 7 ⁵ / ₁₆
3208	135.5 x 185.1	5 ¹¹ / ₃₂ x 7 ⁵ / ₁₆
3308	160.5 x 185.1	6 ¹¹ / ₃₂ x 7 ⁵ / ₁₆
3408	((W÷2) + 7.8) x 185.1	((W÷2) + ⁵ / ₁₆) x 7 ⁵ / ₁₆

W = width
Default exterior profile: B

STANDARD SPECIFICATIONS

- White melamine back
- The default woodgrain direction is vertical

- Drawer fronts are manufactured with reduced rails (unless regular rails are specified)
- Maximum door height: 2438 mm (96"), maximum door width: 1193 mm (47")

SERIES 09 Category 3



Model **2109**
Color: A4WT

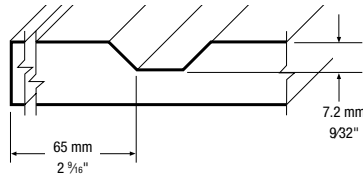

Model **3109**
Reduced rails

Minimum dimensions

Doors (Height x Width)

Model	mm	inches
2109	185.1 x 185.1	7 5/16 x 7 5/16
2209	200.1 x 185.1	7 29/32 x 7 5/16
2309	225.1 x 185.1	8 7/8 x 7 5/16
2409	$((W \div 2) + 71.8) \times 185.1$	$((W \div 2) + 2 27/32) \times 7 5/16$

Drawer fronts (Height x Width)

Model	mm	inches
3109	121.1 x 185.1	4 25/32 x 7 5/16
3209	136.1 x 185.1	5 3/8 x 7 5/16
3309	161.1 x 185.1	6 11/32 x 7 5/16
3409	$((W \div 2) + 7.8) \times 185.1$	$((W \div 2) + 5/16) \times 7 5/16$

W = width
Default exterior profile: B

SERIES 15 Category 2



Model **2115**
Color: A661S

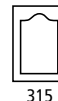
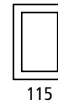
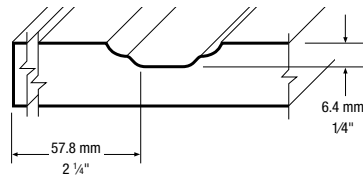

Model **3115**
Reduced rails

Minimum dimensions

Doors (Height x Width)

Model	mm	inches
2115	170.5 x 170.5	6 23/32 x 6 23/32
2215	185.8 x 170.5	7 11/32 x 6 23/32
2315	210.5 x 170.5	8 5/16 x 6 23/32
2415	$((W \div 2) + 63.1) \times 170.5$	$((W \div 2) + 2 1/2) \times 6 23/32$

Drawer fronts (Height x Width)

Model	mm	inches
3115	127.1 x 170.5	5 1/32 x 6 23/32
3215	142.1 x 170.5	5 5/8 x 6 23/32
3315	167.1 x 170.5	6 19/32 x 6 23/32
3415	$((W \div 2) + 19.7) \times 170.5$	$((W \div 2) + 25/32) \times 6 23/32$

W = width
Default exterior profile: U

STANDARD MODELS

OPTIONS:

- See availability of same color melamine back, pages 47-48.
- For regular rails drawer fronts, order as a door.

SERIES 31 Category 3



Model **2131**
Color: K464WT

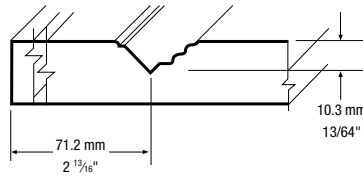

Model **3131**
Reduced rails

Minimum dimensions

Doors (Height x Width)

Model	mm	inches
2131	199.4 x 199.4	7 27/32 x 7 27/32

Drawer fronts (Height x Width)

Model	mm	inches
3131	120.8 x 199.4	4 3/4 x 7 27/32

Default exterior profile: O

SERIES 32 Category 2



Model **2132**
Color: K257S

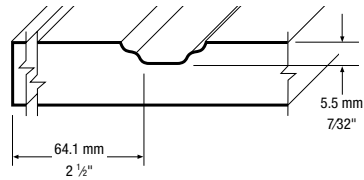

Model **3132**
Reduced rails

Minimum dimensions

Doors (Height x Width)

Model	mm	inches
2132	173.7 x 173.7	6 27/32 x 6 27/32
2232	188.7 x 173.7	7 7/16 x 6 27/32
2332	213.7 x 173.7	8 7/16 x 6 27/32
2432	$((W \div 2) + 68.8) \times 173.7$	$((W \div 2) + 2 23/32) \times 6 27/32$

Drawer fronts (Height x Width)

Model	mm	inches
3132	110.1 x 173.7	4 11/32 x 6 27/32
3232	125.1 x 173.7	4 15/16 x 6 27/32
3332	150.1 x 173.7	5 15/16 x 6 27/32
3432	$((W \div 2) + 5.2) \times 173.7$	$((W \div 2) + 7/32) \times 6 27/32$

W = width

Default exterior profile: C

STANDARD SPECIFICATIONS

- White melamine back
- The default woodgrain direction is vertical

- Drawer fronts are manufactured with reduced rails (unless regular rails are specified)
- Maximum door height: 2438 mm (96"), maximum door width: 1193 mm (47")

SERIES 33 Category 3



Model **2133**
Color: K257S

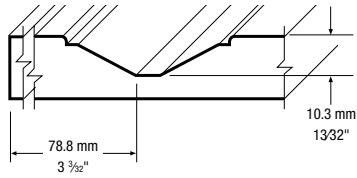

Model **3133**
Reduced rails

Minimum dimensions

Doors (Height x Width)

Model	mm	inches
2133	225.0 x 225.0	8 7/8 x 8 7/8
2233	240.0 x 225.0	9 15/32 x 8 7/8
2333	265.0 x 225.0	10 7/16 x 8 7/8
2433	$((W \div 2) + 82.5) \times 225.0$	$((W \div 2) + 3 1/4) \times 8 7/8$

Drawer fronts (Height x Width)

Model	mm	inches
3133	146.4 x 225.0	5 25/32 x 8 7/8
3233	161.4 x 225.0	6 3/8 x 8 7/8
3333	186.4 x 225.0	7 11/32 x 8 7/8
3433	$((W \div 2) + 3.9) \times 225.0$	$((W \div 2) + 5/32) \times 8 7/8$

W = width
Default exterior profile: A

SERIES 39 Category 3



Model **2139**
Color: K464WT

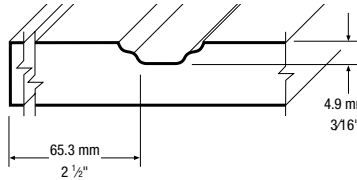

Model **3139**
Reduced rails

Minimum dimensions

Doors (Height x Width)

Model	mm	inches
2139	175.7 x 175.7	6 15/16 x 6 15/16
2239	190.7 x 175.7	7 17/32 x 6 15/16
2339	215.7 x 200.6	8 1/2 x 7 29/32
2439	$((W \div 2) + 70.0) \times 175.7$	$((W \div 2) + 2 25/32) \times 6 15/16$

Drawer fronts (Height x Width)

Model	mm	inches
3139	112.1 x 175.7	4 7/16 x 6 15/16
3239	127.1 x 175.7	5 1/32 x 6 15/16
3339	152.1 x 200.6	6 x 7 29/32
3439	$((W \div 2) + 6.4) \times 175.7$	$((W \div 2) + 9/32) \times 6 15/16$

W = width
Default exterior profile: C

STANDARD MODELS

OPTIONS:

- See availability of same color melamine back, pages 47-48.
- For regular rails drawer fronts, order as a door.

SERIES 46 Category 3



Model **2146**
Color: R82S

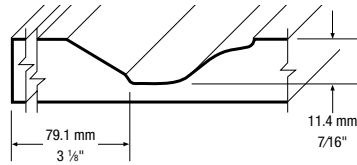

146



246



346



446

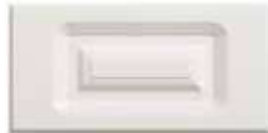

Model **3146**
Reduced rails

Minimum dimensions

Doors (Height x Width)

Model	mm	inches
2146	234.4 x 234.4	9 1/4 x 9 1/4
2246	254.4 x 234.4	10 1/32 x 9 1/4
2346	284.4 x 234.4	11 7/32 x 9 1/4
2446	$((W \div 2) + 86.5) \times 234.4$	$((W \div 2) + 3 \frac{13}{32}) \times 9 \frac{1}{4}$

Drawer fronts (Height x Width)

Model	mm	inches
3146	165.8 x 234.4	6 17/32 x 9 1/4
3246	185.8 x 234.4	7 11/32 x 9 1/4
3346	215.8 x 234.4	8 1/2 x 9 1/4
3446	$((W \div 2) + 17.9) \times 234.4$	$((W \div 2) + \frac{23}{32}) \times 9 \frac{1}{4}$

W = width
Default exterior profile: C

SERIES 47 Category 2



Model **2147**
Color: A15WT

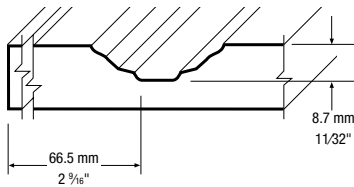

147



247



347



447



Model **3147**
Reduced rails

Minimum dimensions

Doors (Height x Width)

Model	mm	inches
2147	185.5 x 185.5	7 5/16 x 7 5/16
2247	200.5 x 185.5	7 29/32 x 7 5/16
2347	228.5 x 210.0	9 x 8 9/32
2447	$((W \div 2) + 69.8) \times 185.5$	$((W \div 2) + 2 \frac{3}{4}) \times 7 \frac{5}{16}$

Drawer fronts (Height x Width)

Model	mm	inches
3147	129.5 x 185.5	5 1/8 x 7 5/16
3247	144.5 x 185.5	5 23/32 x 7 5/16
3347	172.5 x 210.0	6 13/16 x 8 9/32
3447	$((W \div 2) + 13.8) \times 185.5$	$((W \div 2) + \frac{9}{16}) \times 7 \frac{5}{16}$

W = width
Default exterior profile: C

STANDARD SPECIFICATIONS

- White melamine back
- The default woodgrain direction is vertical
- Drawer fronts are manufactured with reduced rails (unless regular rails are specified)
- Maximum door height: 2438 mm (96"), maximum door width: 1193 mm (47")

SERIES 48 Category 3



Model **2148**
Color: A15WT

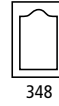
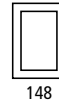
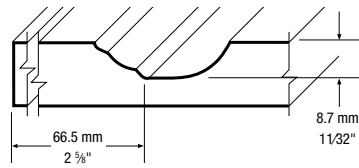

Model **3148**
Reduced rails

Minimum dimensions

Doors (Height x Width)

Model	mm	inches
2148	187.8 x 187.8	7 13/16 x 7 13/32
2248	202.8 x 187.8	8 x 7 13/32
2348	230.8 x 210.0	9 3/32 x 8 9/32
2448	$((W \div 2) + 73.1) \times 187.8$	$((W \div 2) + 2 29/32) \times 7 13/32$

Drawer fronts (Height x Width)

Model	mm	inches
3148	131.8 x 187.8	5 7/32 x 7 13/32
3248	146.8 x 187.8	5 25/32 x 7 13/32
3348	174.8 x 210.0	6 29/32 x 8 9/32
3448	$((W \div 2) + 17.1) \times 187.8$	$((W \div 2) + 1 1/16) \times 7 13/32$

W = width

Default exterior profile: C



SPECIAL MODELS

OPTION:

- See availability of same color melamine back, pages 47-48.

SERIES 911 Category 3



Model **2911**
Color: K85S

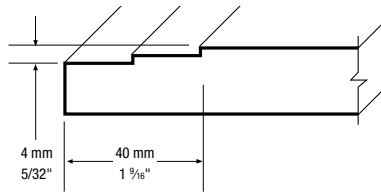

Model **3911**

Minimum dimensions

Doors and drawer fronts (Height x Width)

Model	mm	inches
2911/3911	92.7 x 92.7	3 21/32 x 3 21/32

Default exterior profile: series 911 is manufactured with its own exterior profile.

SERIES 921 / 922 / 923 / 924 Cat. 3



Model **2921**
Color: V66WT

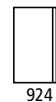
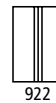
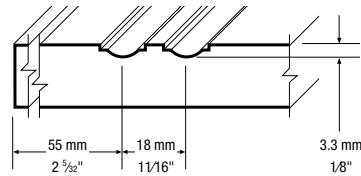

Model **3921**

Minimum dimensions

Doors (Height x Width)

Model	mm	inches
2921	38.1 x 128.0	1 1/2 x 5 1/16
2922	38.1 x 128.0	1 1/2 x 5 1/16
2923	38.1 x 171.4	1 1/2 x 6 3/4
2924	38.1 x 128.0	1 1/2 x 5 1/16

Drawer fronts (Height x Width)

Model	mm	inches
3921	38.1 x 128.0	1 1/2 x 5 1/16
3922	38.1 x 128.0	1 1/2 x 5 1/16
3923	38.1 x 171.4	1 1/2 x 6 3/4
3924	38.1 x 128.0	1 1/2 x 5 1/16

Default exterior profile: series 921 to 924 are manufactured with their own exterior profile.

STANDARD SPECIFICATIONS

- White melamine back
- The default woodgrain direction is vertical
- Drawer fronts are manufactured with reduced rails (unless regular rails are specified)
- Maximum door height: 2438 mm (96"), maximum door width: 1193 mm (47")

SERIES 972 Category 3



Model **2972**
Color: V66WT

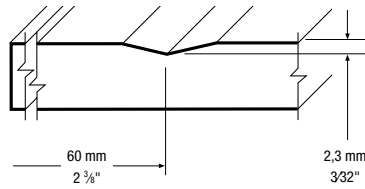

Model **3972**
Reduced rails



Model **3975**
Reduced rails

Minimum dimensions

Doors (Height x Width)

Model	mm	inches
2972	264.2 x 213.7	10 ¹³ / ₃₂ x 8 ⁷ / ₁₆

Drawer fronts (Height x Width)

Model	mm	inches
3972	144.2 x 213.7	5 ¹¹ / ₁₆ x 8 ⁷ / ₁₆
3975	144.2 x 273.1	5 ¹¹ / ₁₆ x 10 ³ / ₄

Default exterior profile: B

SERIES 974 Category 4



Model **2974**
Color: K85S

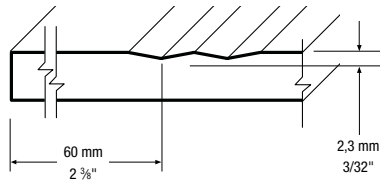

Model **3974**
Reduced rails

Minimum dimensions

Doors (Height x Width)

Model	mm	inches
2974	213.7 x 213.7	8 ⁷ / ₁₆ x 8 ⁷ / ₁₆

Drawer fronts (Height x Width)

Model	mm	inches
3974	164.2 x 213.7	6 ¹⁵ / ₃₂ x 8 ⁷ / ₁₆

Default exterior profile: B

SPECIAL MODELS

STANDARD SPECIFICATIONS

- White melamine back
- The default woodgrain direction if vertical

- Drawer fronts are manufactured with reduced rails (unless regular rails are specified)
- Maximum door height: 2438 mm (96"), maximum door width: 1193 mm (47")

SERIES 996 Category 3



Model **2996**
Color: A661S



Model **3996**

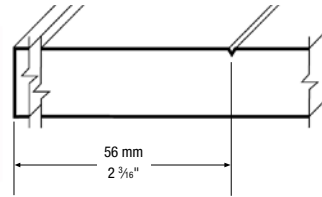

FRAME DOOR

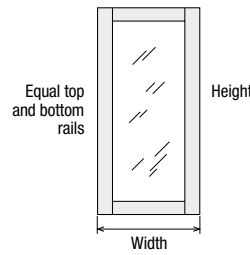

Minimum dimensions

Doors and drawer fronts (Height x Width)

Model	mm	inches
2996/3996	38.1 x 162.8	1 1/2 x 6 7/16

Note: Not available with exterior profiles D, F, H and P.
Default exterior profile: Y

The first groove is 48 mm (1-57/64") from the top of the door. Door rails height vary according to door dimensions.

ALIGNMENT OF ADJACENT DOORS AND DRAWERS

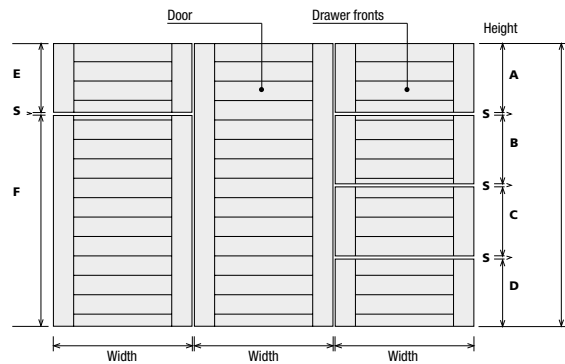

A, B, C, D, E, F and G: height of doors and drawers. / S: vertical space required between drawers.
To align the grooves with other doors and drawers front, please specify it when ordering and provide us a drawing.

VERTICAL CROSS SECTION

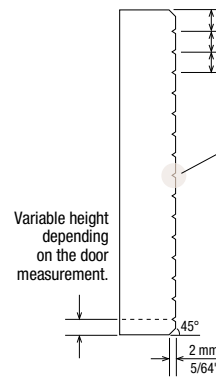

HORIZONTAL CROSS SECTION

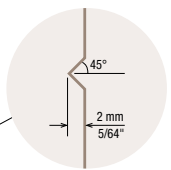

SERIES 939 Category 3



Model **2939**
Color: A4WT

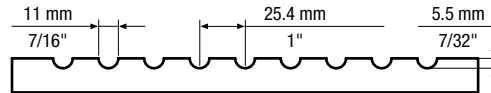

The first groove starts at the center of the door.

Minimum dimensions

Doors (Height x Width)

Model	mm	inches
2939	76.2 x 76.2	3 x 3

Default exterior profile: Q

The width of the stiles vary according to door dimensions.

GROOVES ON CENTER PANELS



Color: K464WT



Single Vertical Grooves

If you require vertical grooves on your center panel, please choose this option when you place your order.

The vertical groove options on center panel are available on most door models. Please contact Customer Service for more information.

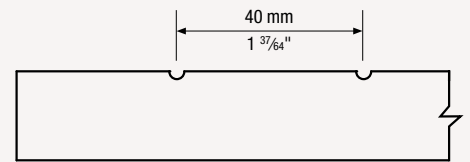

Color: K464WT



Double Vertical Grooves

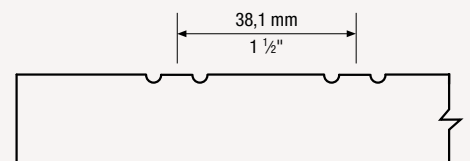



PERSONALIZED SIGNATURE

FRAME AND
MULLION DOORS

PANELS

MOULDINGS

ACCESSORIES

TECHNICAL
SPECIFICATIONS

FRAME AND MULLION DOORS



Model **4101**
Color: V67WT

Standards

SERIES 4100

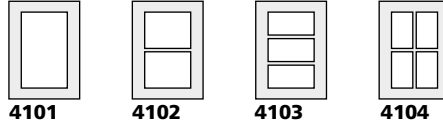

4101 **4102** **4103** **4104**

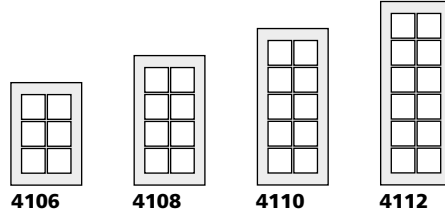

4106 **4108** **4110** **4112**

SERIES 4200

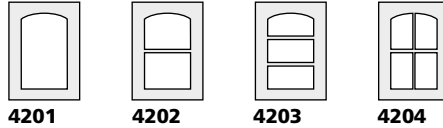

4201 **4202** **4203** **4204**

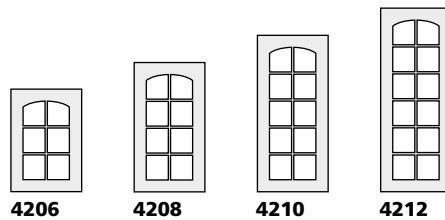

4206 **4208** **4210** **4212**

SERIES 4300



4301 **4302** **4303** **4304**

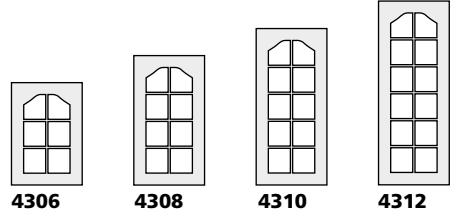

4306 **4308** **4310** **4312**

SERIES 4400



4401 **4402** **4403** **4404**

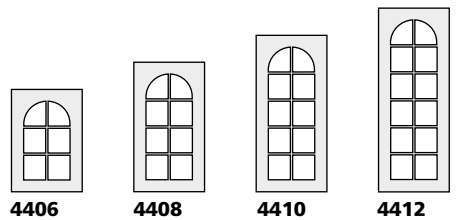

4406 **4408** **4410** **4412**



Model **4106**
Color: V67WT

Specials

SERIES 6300-6400

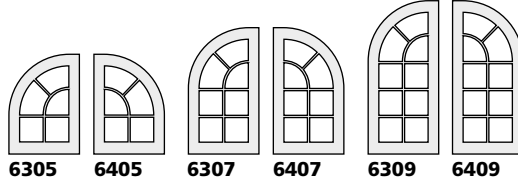

6305 **6405** **6307** **6407** **6309** **6409**

SERIES 6700

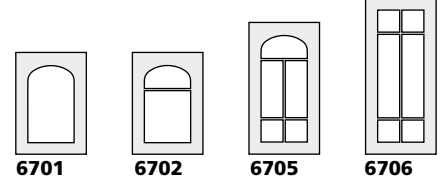

6701 **6702** **6705** **6706**

SERIES 6500-6600

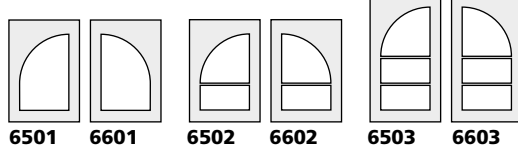

6501 **6601** **6502** **6602** **6503** **6603**

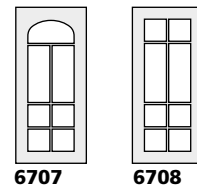

6707 **6708**

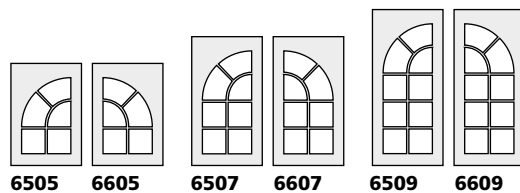

6505 **6605** **6507** **6607** **6509** **6609**

SERIES 6900

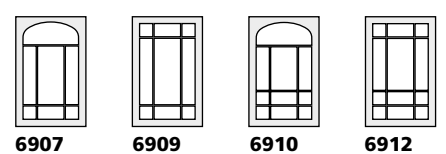

6907 **6909** **6910** **6912**

FRAME AND MULLION DOORS

OPTION:

MDF core will be visible on the back of the frame or mullion door. It can be painted on request.

SPECIFICATIONS

- 1) For special frame and mullion doors (except series 6900), the door widths must be identical.
- 2) An interior profile must be specified for frame and mullion doors ordered with models 00, 79, 80, 910 (default profile 51) and 911, 912 (default profile 09).
- 3) Series 83 to 89 are only available in special mullion door models 6706, 6708, 6909 and 6912. This restriction does not apply to series 93 to 99.
- 4) Models 942 and 996 frame and mullion doors are available only in 4100 series.

Glass insert sizes

Model	Height		Width	
	mm	inches	mm	inches
01-03-04-06-07-27-31-33-46-71-73-974	H - 115	H - 4 1/2	W - 115	W - 4 1/2
08-09-32-39-47-48-49-50-51-52-55-56-58-70-72-76-77-78-83-85-86-87-88-89-93-95-96-97-98-99-167-767-942-972	H - 102	H - 4	W - 102	W - 4
921-922-924	H - 91	H - 3 9/16	W - 127	W - 5
923	H - 91	H - 3 9/16	W - 163	W - 6 7/16
996	H - 88	H - 3 1/2	W - 102	W - 4
41-61-62-65-66-164-764	H - 127	H - 5	W - 127	W - 5

H = Height W = width

SPECIFICATIONS

Suggested glass thickness: 3 mm (1/8") to 5 mm (3/16").

For glass over 1219 mm (48"), glass thickness of 5 mm (3/16") is suggested.

Glass Retainer Moulding

Model	Colors
5351	Clear
5350	White



GLASS INSTALLATION

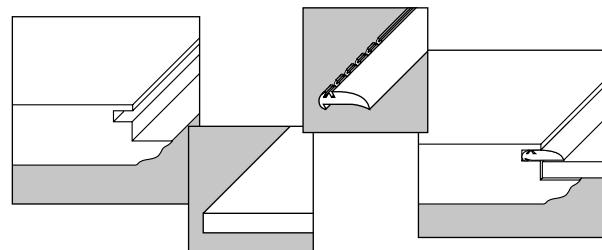

Minimum dimensions

Lites	Height x Width	
	mm	inches
01	203.2 x 203.2	8 x 8
02	279.4 x 203.2	11 x 8
03	368.3 x 203.2	14 1/2 x 8
04	279.4 x 279.4	11 x 11
06	368.3 x 279.4	14 1/2 x 11
08	457.2 x 279.4	18 x 11
10	546.1 x 279.4	21 1/2 x 11
12	635.0 x 279.4	25 x 11

Lites	Height x Width
01	*
02	≥ W
03	≥ 1.4 x W
04	≥ W
06	≥ 1.4 x W
08	≥ 1.8 x W
10	≥ 2.2 x W
12	≥ 2.6 x W

* Frames 4401 have the same minimum dimensions as their corresponding door model (ex.: 401, etc.).

Series	Width
6305 - 6405	≥ 1.4 x W
6307 - 6407	≥ 1.6 x W
6309 - 6409	≥ 2 x W
6501 - 6601	≥ W
6502 - 6602	≥ 1.4 x W
6503 - 6603	≥ 1.6 x W
6505 - 6605	≥ 1.4 x W
6507 - 6607	≥ 1.6 x W
6509 - 6609	≥ 2.0 x W

The center of the radius is not calculated from the door rail. Please contact Customer Service for more information.

Series	Width
6701	≥ 0.6 x W
6702	≥ 0.9 x W
6705	≥ 1.5 x W
6706	≥ 1.5 x W
6707	≥ 1.9 x W
6708	≥ 1.9 x W

Series	Height x Width
6907	500 x 444.5 19 11/16 x 17 1/2
6909	425 x 444.5 16 3/4 x 17 1/2
6910	600 x 444.5 23 5/8 x 17 1/2
6912	525 x 444.5 20 11/16 x 17 1/2

Multiple Panels

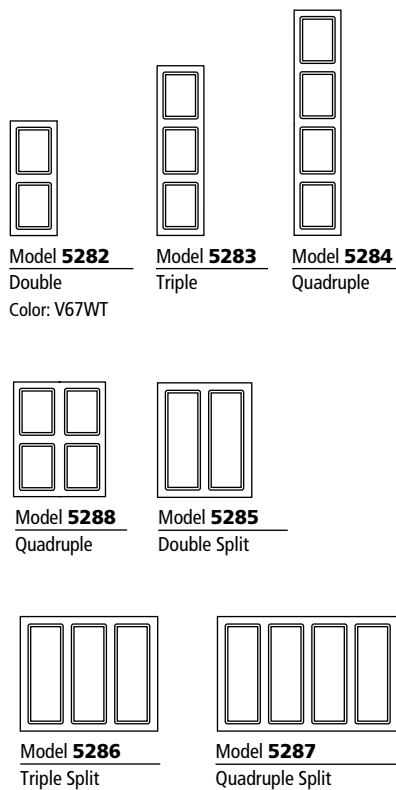

Appliance Panels

Appliance panels are available in the same models as the doors and multiple panels. However, their exterior is modified, as shown, to simplify their insertion.

Exterior profile **A** in this example.
Available exterior profiles: A, B, C, F, I, J, L, Y

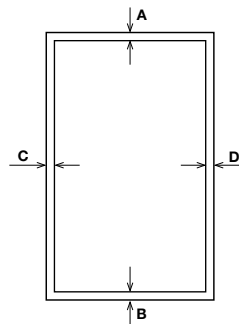
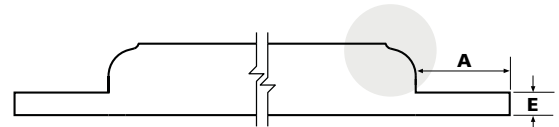

Model **5270**
Simple

SPECIFICATIONS

Values from **A** to **E** must be specified. If not specified, default value for **E** will be 6.35 mm (1/4"). Minimum thickness for **E** is 4.76 mm (3/16").

AVAILABLE MODELS

- Simple (5270)
- Double (5272)
- Double Split (5275)
- Triple (5273)
- Triple Split (5276)
- Quadruple (5274, 5278)
- Quadruple Split (5277)

Frame for built-in appliances



Model **5566**
Color: R205W

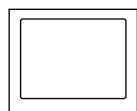

Model **5560**

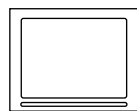

Model **5561**

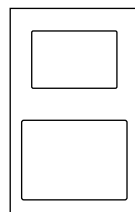

Model **5567**

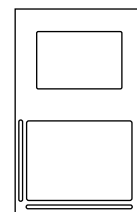

Model **5569**

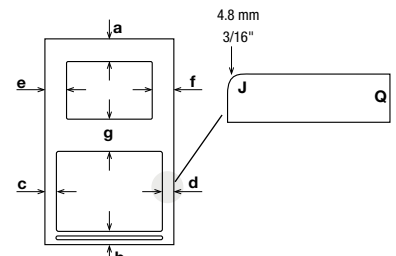

Model **5568**

SPECIFICATIONS

- 1) Inner and outer frame are available in all exterior profiles. Profiles by default are **J** for the interior profile and **Q** for the exterior profile.
- 2) Vents are centered on the height and width of the rail.
- 3) Minimum rails dimensions:
 - with vent, 50 mm (2");
 - without vent, 38.1 mm (1 1/2")
- 4) For models 5567, 5568 and 5569, please specify at least 1 opening height.

MOULDINGS AND ACCESSORIES

Thermoplastic Laminated Panels

Laminated particle board panels – Unilam (Phenolic paper)

ONE SIDE: THERMO FRONT / UNILAM BACK

- 5011 : 15.86 mm x 1.2 m x 2.7 m (5/8" x 4' x 9')
- 5013 : 15.86 mm x 1.2 m x 2.4 m (5/8" x 4' x 8')
- 5015 : 19.05 mm x 1.2 m x 2.4 m (3/4" x 4' x 8')

BOTH SIDES: THERMO FRONT / THERMO BACK

- 5010 : 15.86 mm x 1.2 m x 2.7 m (5/8" x 4' x 9')
- 5012 : 15.86 mm x 1.2 m x 2.4 m (5/8" x 4' x 8')
- 5019 : 19.05 mm x 1.2 m x 2.4 m (3/4" x 4' x 8')

Laminated MDF Panels – MDF (one side)

THERMO FRONT / RAW MDF BACK

- 5014 : 6.3 mm x 1.2 m x 2.4 m (1/4" x 4' x 8')
- 5018 : 3.18 mm x 1.2 m x 2.4 m (1/8" x 4' x 8')
- 5027 : 19.05 mm x 1.2 m x 2.7 m (3/4" x 4' x 9')

Laminated MDF Panels (Both sides)

THERMO FRONT / THERMO BACK

- 5017 : 19.05 mm x 1.2 m x 2.7 m (3/4" x 4' x 9')
- 5026 : 15.86 mm x 1.2 m x 2.4 m (5/8" x 4' x 8')

Laminated Melamine Panels – Melamine (one side)

THERMO FRONT / MELAMINE BACK

- 5016 : 19.05 mm x 1.2 m x 2.7 m (3/4" x 4' x 9')
- 5024 : 15.86 mm x 1.2 m x 2.7 m (5/8" x 4' x 9')
- 5025 : 15.86 mm x 1.2 m x 2.4 m (5/8" x 4' x 8')

Note: See pages 47-48 for specifications and colors availability.

Wine Racks

CIRCLE OPENINGS



Model **5132**
Color: F435WT



Model **5133**
Color: F435WT

SPECIFICATIONS

- If models 5132 and 5133 are paired together, it must be specified when placing your order.
- Minimum dimensions:
5132: 76.2 mm (3") height
5133: 69.8 mm (2 3/4") height



Model **5134**
Color: F435WT

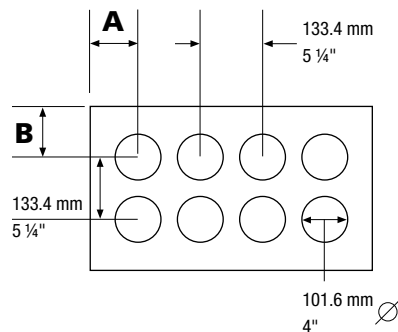

SPECIFICATIONS

- 1) Standard opening diameter: 101.6 mm (4")
- 2) Distance from the center of one opening to the center of the next.: 133.4 mm (5 1/4")
- 3) $A = \frac{\text{Width} - (\text{number of holes} - 1) \times 133.4 \text{ mm}}{\text{Width} - (\text{number of holes} - 1) \times 5 \frac{1}{4} \text{''}} \div 2$
 $B = \frac{\text{Height} - (\text{number of holes} - 1) \times 133.4 \text{ mm}}{\text{Height} - (\text{number of holes} - 1) \times 5 \frac{1}{4} \text{''}} \div 2$
- 4) **A** or **B** minimum dimension: 76.2 mm (3")

Model **5138**
Color: F435WT

DIAMOND OPENINGS



Model **5141**
Color: R205W



Model **5142**
Color: R205W



Model **5143**
Color: R205W

SPECIFICATIONS

Opening size: 101.6 x 101.6 mm (4" x 4")

Product	Number of openings	Minimum dimension		Maximum dimension	
		mm	in.	mm	in.
5134/5138	1	152.4	6	285.7	11 1/4
	2	285.8	11 1/4	419.0	16 1/2
	3	419.1	16 1/2	501.6	19 3/4
	4	552.5	21 3/4	685.7	27
	5	685.8	27	819.1	32 1/4
	6	819.2	32 1/4	952.4	37 1/2
5141/5142	1	239.4	9 3/8	427.9	16 7/8
	2	428.0	16 7/8	616.5	24 1/4
	3	616.6	24 1/4	805.0	31 3/4
	4	805.1	31 3/4	993.6	39 1/8
	5	993.7	39 1/8	1182.2	46 1/2
	6	1182.3	46 1/2	1370.8	54
5143	1	194.5	7 3/8	383.0	15 1/8
	2	383.1	15 1/8	571.6	22 1/2
	3	571.7	22 1/2	760.1	29 7/8
	4	760.2	29 7/8	948.7	37 3/8
	5	948.8	37 3/8	1137.3	44 3/4
	6	1137.4	44 3/4	1325.9	52 1/4

MOULDINGS AND ACCESSORIES

Decorative Mouldings

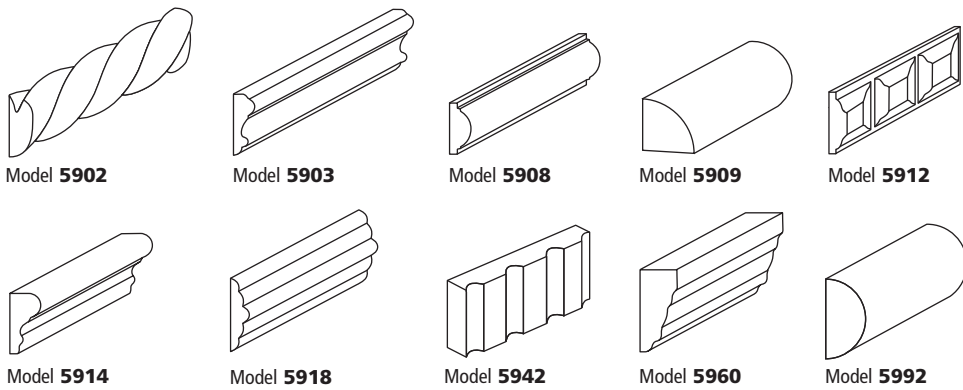

Model	Height x Thickness	
	mm	inches
5767	40.6 x 15.2	1 5/8 x 5/8
5902	17.5 x 7	11/16 x 9/32
5903	20.6 x 6.4	13/16 x 1/4
5908	19 x 8	3/4 x 5/16
5909	19 x 19	3/4 x 3/4
5912	22.2 x 8	7/8 x 5/16
5914	25.4 x 12	1 x 15/32
5918	27 x 6.4	1 1/16 x 1/4
5942	25.4 x 19	1 x 3/4
5960	35 x 16	1 3/8 x 5/8
5992	38 x 19	1 1/2 x 3/4

SPECIFICATIONS

- 1) Available in 2.4 m (8') lengths.
- 2) Definition of certain details varies according to the thickness of the thermoplastic foil.
- 3) Models 5902 and 5912 come in 2.38 m (94") lengths.

Trim Moulding

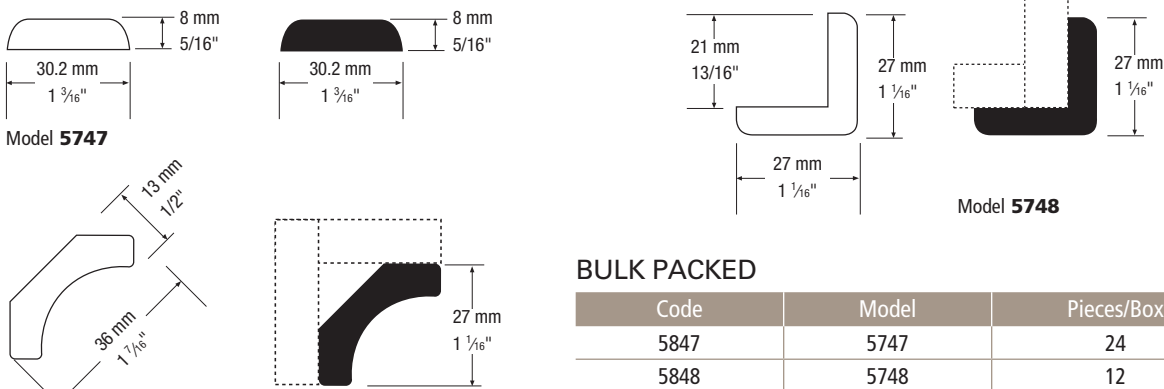

BULK PACKED

Code	Model	Pieces/Box
5847	5747	24
5848	5748	12
5858	5758	2

NOTE: Certain Color restrictions apply. Please consult price list.

Decorative moulding

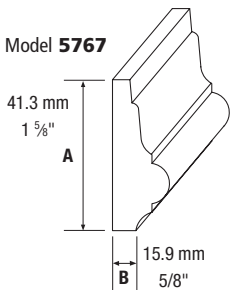

Model 5767

41.3 mm
1 5/8"
A
15.9 mm
5/8"
B

Decorative Base

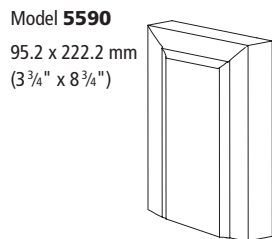

Model 5590
95.2 x 222.2 mm
(3 3/4" x 8 3/4")

Decorative corner



Model 5531

Minimum dimensions

Decorative corner Height x Thickness		
Épaisseur	mm	inches
3/4"	76.2 x 76.2	3 x 3
1"	76.2 x 76.2	3 x 3

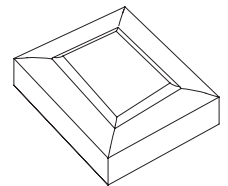

Model 5540
95.2 x 95.2 mm
(3 3/4" x 3 3/4")

Baseboards

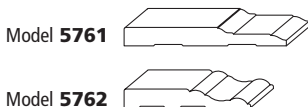

Model 5761

Model 5762

Model	Height x Thickness	
	mm	inches
5760	165.1 x 15.2	6 1/2 x 5/8
5761	139.7 x 15.2	5 1/2 x 5/8
5762	108 x 15.2	4 1/4 x 5/8

Frame mouldings

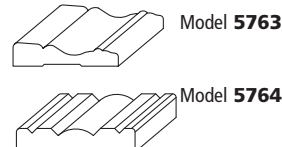

Model 5763

Model 5764

Model	Height x Thickness	
	mm	inches
5763	68.3 x 15.2	2 11/16 x 5/8
5764	79.4 x 15.2	3 1/8 x 5/8

MOULDINGS AND ACCESSORIES

Crown mouldings

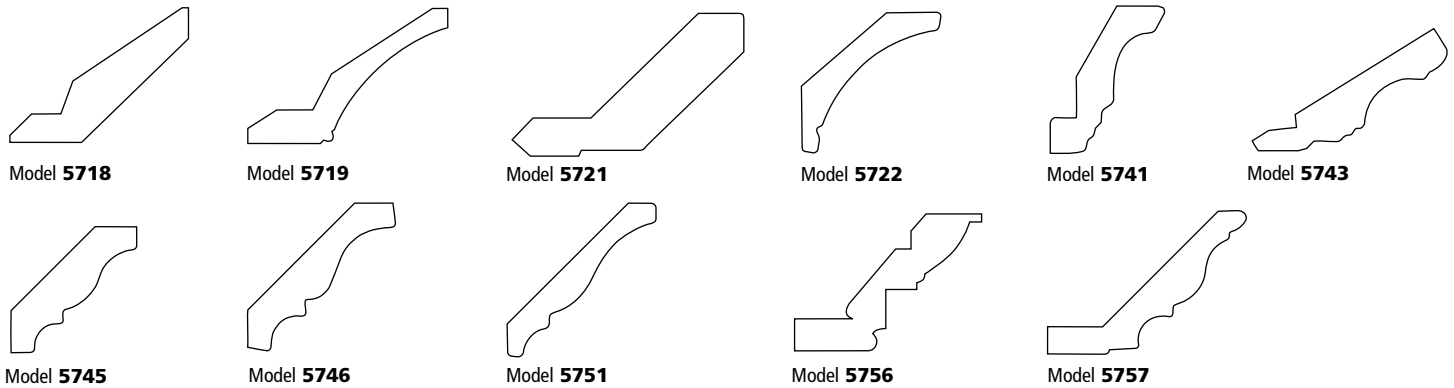

Model	Height x Thickness	
	mm	inches
5718	99.1 x 24.6	3 15/16 x 3 1/2
5719	99.1 x 25	3 15/16 x 1
5721	65.1 x 19.1	2 9/16 x 3/4
5722	102.25 x 31.71	4 x 3/4
5741	76.2 x 17.5	3 x 1 1/16
5743	90.5 x 17.5	3 9/16 x 1 1/16
5745	69.9 x 17	2 3/4 x 43/64
5746	80.2 x 17.5	3 5/32 x 1 1/16
5751	108 x 15	4 1/4 x 19/32
5756	88.9 x 19.1	3 1/2 x 3/4
5757	139.7 x 30	5 1/2 x 1 1/64

SPECIFICATIONS

- Available in 2.4 m (8') lengths.
- Available in all colors.

BULK PACKED

Code	Model	Pieces/Box
5841	5741	4
5843	5743	4
5845	5745	4
5846	5746	4
5856	5756	2
5857	5757	2

Note: some Color restrictions apply. Please consult price list.

Installation

METHOD 1

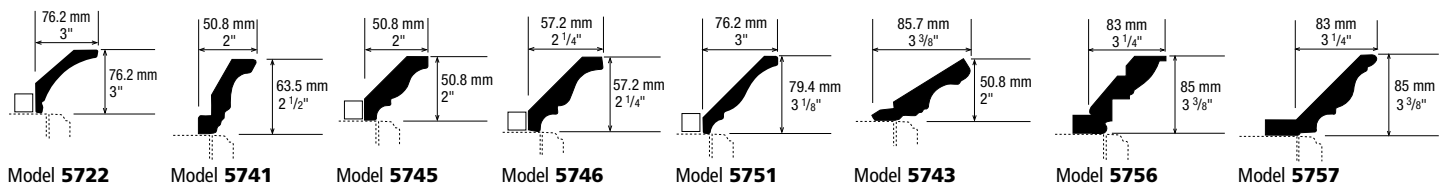

METHOD 2

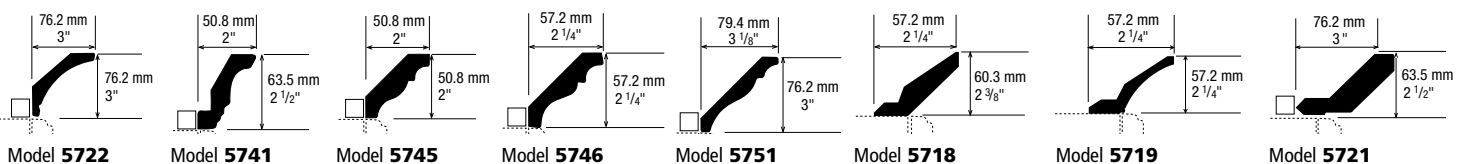

Crown mouldings should be glued and clamped rather than nailed.

MOULDINGS AND ACCESSORIES

3" Standard Valances

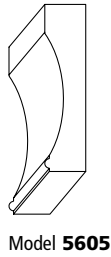
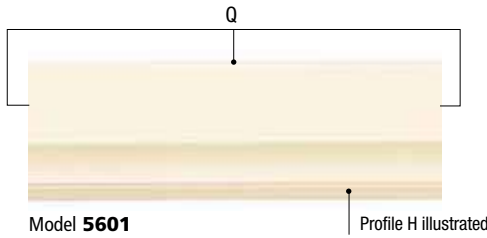

SPECIFICATIONS

- 1) Standard valances are 76.2 mm (3") high with the bottom edge profiled.
- 2) All exterior profiles are available. (See page 2)
- 3) 5601 (profiled 1 side), 5602 (profiled 2 sides) = 76.2 mm (3")
- 4) Woodgrain direction is horizontal.

- 5) To order flat customized fillers, base mouldings or valances, order product 2000 and 3000.
- 6) Minimum charge of 0.19 sq.m (2 sq.ft) for thermoplastic valances whose height or width is less than 76.2 mm (3") and whose length is greater than 1828 mm (72").

Custom Valances



Model 5610
Color: C72R



Model 5620
Color: C72R



Model 5631
Color: C72R



Model 5640
Color: C72R



Model 5650
Color: C72R

Valances (Designer Series)



Model 5510
Country Manor

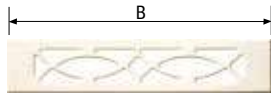

Model 5520
Country Cottage

Model	Minimum dimensions				Standard dimensions			
	A		B		A		B	
	mm	in.	mm	in.	mm	in.	mm	in.
5510 Country Manor	152	6	235	9 1/4	152	6	762	30
5520 Country Cottage	152	6	304.8	12	152	6	762	30

SPECIFICATIONS

- 1) Back routing is identical to frame and mullion doors.
- 2) Model 5520 "Eye Shaped" pattern repeated every 355.6 mm (14").
- 3) All profiles available except D, F, H and P.
- 4) If width < 44", woodgrain direction is vertical.
- 5) If width > 44", woodgrain direction is horizontal.

Standards

Custom valance standard dimensions have been established as shown below.

Therefore, custom valances ordered outside of these standards will require special programming.

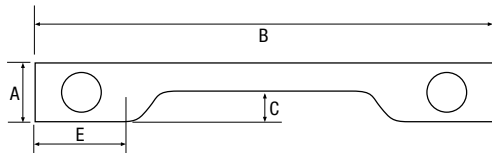

Models 5610-5611-5616

- If $B < 609.6$ mm (24"), $E = 76.2$ mm (3")
- If $B \geq 609.6$ mm (24"), $E = 152.4$ mm (6")
- If $A < 203.2$ mm (8"), $C = 50.8$ mm (2")
- If $A \geq 203.2$ mm (8"), $C = 101.6$ mm (4")

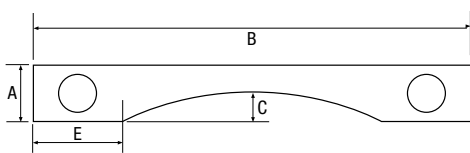

Models 5620-5621-5626, 5630-5631-5636

- E is variable
- If $B < 508$ mm (20"), E minimum size is 76.2 mm (3") and E maximum size is 101.6 mm (4")
- If $B \geq 508$ mm (20"), E minimum size is 76.2 mm (3") and E maximum size is 165.1 mm (6 1/2")
- If $A < 203.2$ mm (8"), $C = 50.8$ mm (2")
- If $A \geq 203.2$ mm (8"), $C = 101.6$ mm (4")

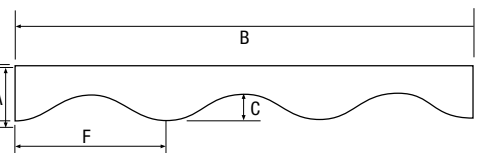

Models 5640

- If $B < 762$ mm (30"), $F = 127$ mm (5") and $C = 25.4$ mm (1")
- If $B \geq 762$ mm (30"), $F = 254$ mm (10") and $C = 50.8$ mm (2")

Minimum dimensions

Model	A		B	
	mm	in.	mm	in.
5610 plain	101,6	4	330,2	13
5611 with 2 routed circles	101,6	4	330,2	13
5616 with 2 applied rosette	101,6	4	330,2	13
5620 plain	101,6	4	304,8	12

Model	A		B	
	mm	in.	mm	in.
5621 with 2 routed circles	101,6	4	304,8	12
5626 with 2 applied rosette	101,6	4	304,8	12
5630 plain	101,6	4	304,8	12
5631 with 2 routed circles	101,6	4	304,8	12

Model	A		B	
	mm	in.	mm	in.
5636 with 2 applied rosette	101,6	4	304,8	12
5640 plain	101,6	4	254	10
5650 plain	101,6	4	152,4	6

SPECIFICATIONS

- 1) Only the bottom edge is profiled. Please specify the edge profile.
- 2) Rosettes are centred vertically in the A dimension and horizontally in the E dimension.
- 3) Woodgrain pattern is horizontal. (Exeptions may apply, please contact Customer Service for further information.)

MOULDINGS AND ACCESSORIES

Rosettes



Model **5530**
Color: C72R



Model **5580**
Color: C72R

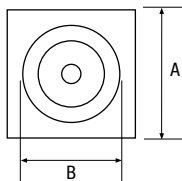

Standard dimensions

Model	A		B		C	
	mm	in.	mm	in.	mm	in.
5530 circle route	76.2	3	68	2 11/16	19.1 – 25	3/4 – 1
5580 applied rosette	76.2	3	63.5	2 1/2	19.1 – 25	3/4 – 1

SPECIFICATIONS

- 1) Not available with exterior profiles: **H**, **P** and **V**.
- 2) A minimum of 88.9 mm (3 1/2") is required for all profiles except **Q** and **Y**.
- 3) Available with white back only.

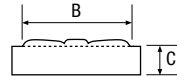
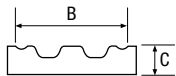

3" Radius Corners



Model **5300** Standard lengths
800 mm (31 1/2")

Model **5310** Standard lengths
2440 mm (96")

SPECIFICATIONS

- 1) Standard lengths: 800 mm (31 1/2"), 2440 mm (96"). Custom lengths also available as an option.

Shaker Filler

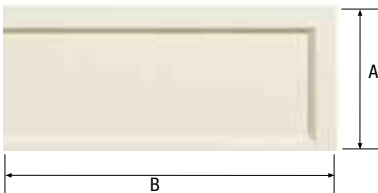

Model **5450**
Color: C72R

Standard dimensions

Model	A		B	
	mm	in.	mm	in.
5450	76.2	3	813	32

SPECIFICATIONS

- 1) Default exterior profile: **Q**.
- 2) Not available with exterior profiles: **H**, **P** and **V**.
- 3) Different lengths are available on request for **A** and **B**.

Fillers



Standard dimensions

Model	Description	A		B		C		D		E		F	
		mm	in.	mm	in.	mm	in.	mm	in.	mm	in.	mm	in.
5400	plain	76.2	3	–	–	813	32	–	–	–	–	–	–
5401	with 2 routed circles	76.2	3	114.3	4 1/2	813	32	–	–	–	–	68	2 11/16
5406	with 2 applied rosettes	76.2	3	114.3	4 1/2	813	32	–	–	–	–	63.5	2 1/2
5410	1 staggered groove	76.2	3	–	–	813	32	–	–	50.8	2	–	–
5411	1 staggered groove with 2 routed circles	76.2	3	114.3	4 1/2	813	32	177.8	7	50.8	2	68	2 11/16
5416	1 staggered groove with 2 applied rosettes	76.2	3	114.3	4 1/2	813	32	177.8	7	50.8	2	63.5	2 1/2
5420	2 grooves	76.2	3	–	–	813	32	177.8	7	–	–	–	–
5421	2 grooves with 2 routed circles	76.2	3	114.3	4 1/2	813	32	177.8	7	–	–	68	2 11/16
5426	2 grooves with 2 applied rosettes	76.2	3	114.3	4 1/2	813	32	177.8	7	–	–	63.5	2 1/2
5429	2 full length grooves	76.2	3	–	–	813	32	–	–	–	–	–	–
5430	3 grooves	76.2	3	–	–	813	32	177.8	7	–	–	–	–
5431	3 grooves with 2 routed circles	76.2	3	114.3	4 1/2	813	32	177.8	7	–	–	68	2 11/16
5436	3 grooves with 2 applied rosettes	76.2	3	114.3	4 1/2	813	32	177.8	7	–	–	63.5	2 1/2
5439	3 full length grooves	76.2	3	–	–	813	32	–	–	–	–	–	–

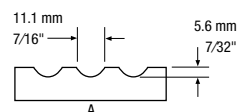
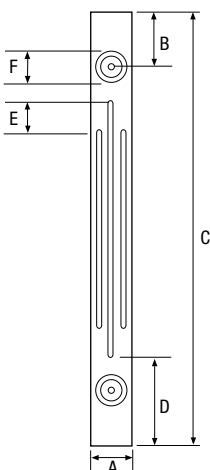

Note: If **C** is < 609,6 mm (24")

B = 38,1 mm (1 1/2")

D = 101,6 mm (4")

E = 25,4 mm (1")

SPECIFICATIONS

- 1) Default exterior profile: **Q**.
- 2) Not available with exterior profiles: **H**, **P** and **V**.
- 3) The ratio is one groove per inch unless specified otherwise.
- 4) Different lengths are available on request for **A**, **B**, **C**, **D**, **E**.

MOULDINGS AND ACCESSORIES

Heatshield Fillers

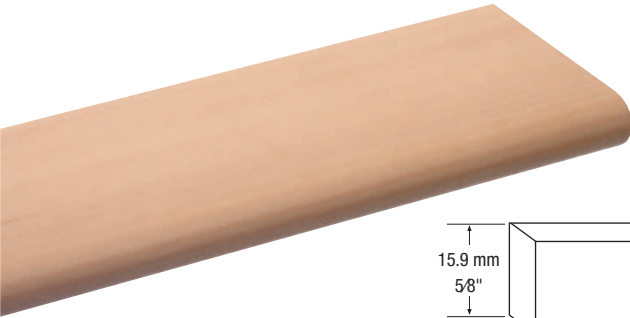

Heatshield fillers are high-heat-resistant fillers/spacers for kitchen cabinet installations near a heat source. **HPL Heatshield fillers** are postformed components with a 180° profile, subjected to pretesting at temperatures exceeding 120°C (250°F) without delamination

Produced with compatible HPL, they are available in most colors. Please contact Customer Service for an up-to-date list of available colors..

SPECIFICATIONS

Model	m	ft
5315	1.2	4
5316	2.4	8

A 25.4 mm (1") HPL strip is supplied with each heatshield filler. After cutting the heatshield filler to size, use the edgebanding strip to finish the ends.

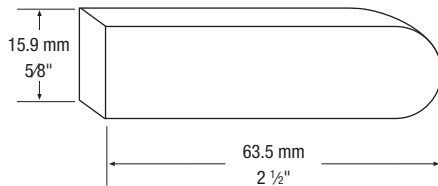

Installation

CLEAR PLASTIC HEATSHIELD FILLERS

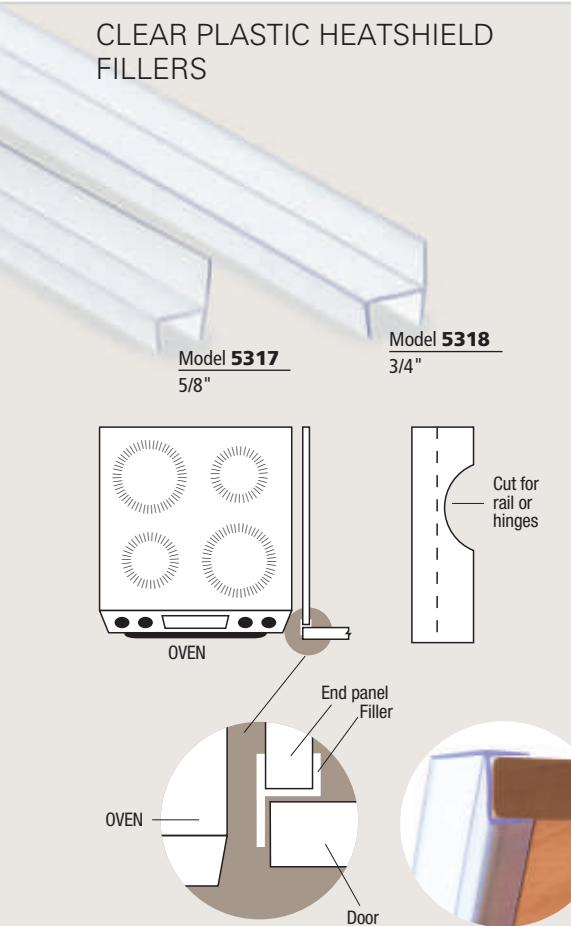

The clear plastic heatshield is a great option for cabinet installation close to a heat source. With the same resistance to heat as the HPL Heatshield fillers (250 °F / 120 °C), this clear plastic heatshield is compatible with all thermoplastic colors. It is easily installed along the edge of the end panel and requires no adhesive. If installing the heatshield around hinges or rails, a simple cut on the interior of the heatshield is sufficient.

WALL MOUNTED OVENS

The use of heatshield fillers is recommended, as mentioned for base ovens and cooktops. In addition, a 5/8"-3/4" filler should be fitted horizontally between the oven and the top door, aligned with the door surface.

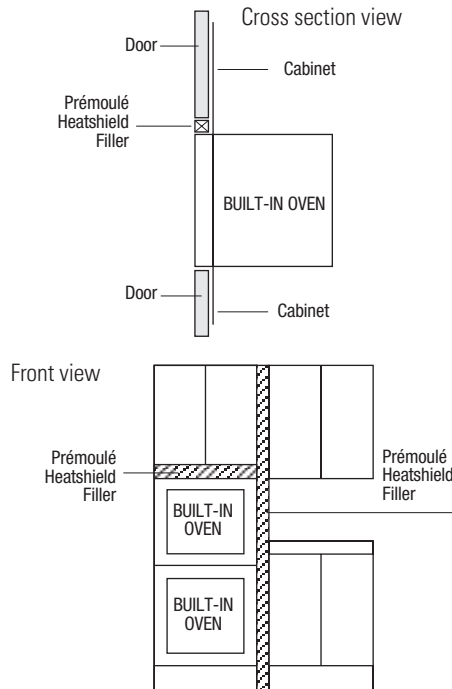

BASE OVENS AND COOK TOPS

The heatshield filler must be mounted so that its surface is aligned with the adjacent door surface. The same recommendation applies to cook tops with front exhaust vents. The filler act as a shield against excessive radiant and convective heat associated with broiling (with the oven door open) and ovens with self-cleaning features.

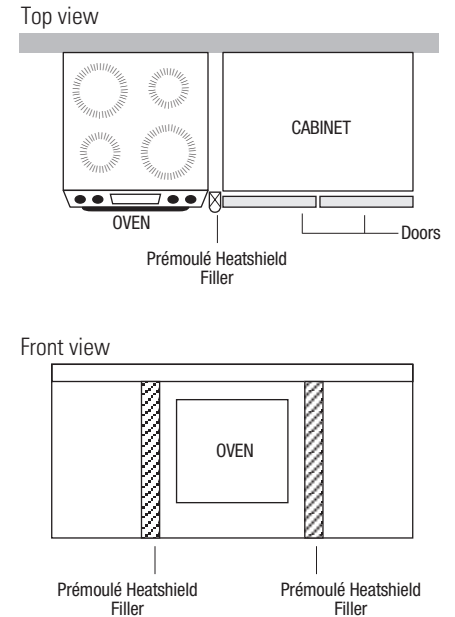

WALL MOUNTED MICROWAVE OVENS AND UNDERMOUNT COFFEE MAKERS

The heatshield filler mounted flush, or protruding slightly beyond the face surfaces of doors above, is recommended. This precludes possible surface damage and swelling of core material from excessive heat and/or steam.

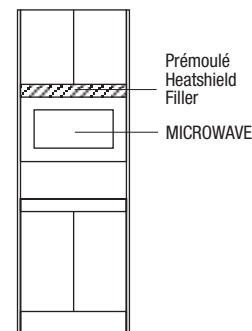

RESTRICTION

Counter top appliances: Care must be taken when using toasters, toaster ovens, portable grills and other heat/steam generating appliances to ensure that upper cabinet doors are not subjected to excessive temperatures

MOULDINGS AND ACCESSORIES

Corner Shelves

SHELF WITH RADIUS



Model **5120**

NOTE: Same Color melamine back available.

SHELF WITH ELLIPSE



Model **5121**

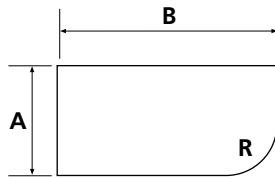

If **A** or **B** < 203.2 mm (8"), **R** = 88.9 mm (3 1/2")

If **A** and **B** ≥ 203.2 mm (8"), **R** = 190.5 mm (7 1/2")

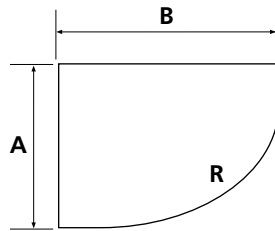

If **A** or **B** sizes are between:

101.6 mm (4") – 152.4 mm (6"), **R** = 101.6 mm (4")

152.4 mm (6") – 203.2 mm (8"), **R** = 152.4 mm (6")

203.2 mm (8") – 254 mm (10"), **R** = 203.2 mm (8")

254 mm (10") – 381 mm (15"), **R** = 254 mm (10")

NOTE: Minimum size for **A** and **B** is 89 mm (3 1/2")

Decorative Tambours

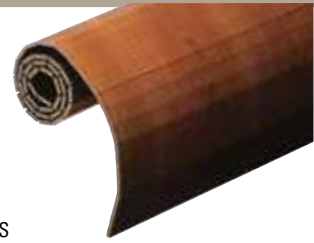

Available dimensions

Model Thickness 3.2 mm x 1/8 in.	Model Thickness 6.4 mm x 1/4 in.	m	pi.
5005	5005	0.6 x 0.6	2 x 2
5003	5052	0.6 x 1.2	2 x 4
5054	5054	1.2 x 1.2	4 x 4

SPECIFICATIONS

- Strip width: 12.7 mm (1/2")
First strip: 38.1 mm (1 1/2")
- The default woodgrain direction is vertical.
Horizontal woodgrain available as an option.

Thermoplastic Foil

Thermoplastic sheet
Length must be specified

- 5000: 1.2 m (4') wide.

Peel and stick

- 5040: 1.2 m x 2.4 m (4' x 8')
Length must be specify

Thermoplastic on phenolic

- 5060: 1.2 m x 2.4 m (4' x 8')

Note: See pages 47-48 for the available colors.

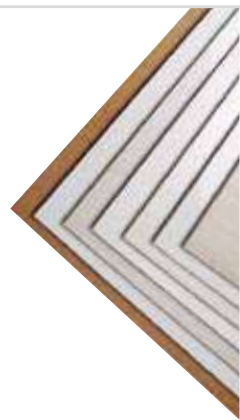

Edgebanding

Our thermoplastic edgebanding is formulated to be used with edgebanding machines operating at 77 °C (170 °F). Since standard edgebanding machines run at 88 °C (190 °F) to 99 °C (210 °F), we also offer PVC edgebanding which can be applied with the standard machines. Available finishes for each type of edgebanding are listed in the table on page 47-48.

Thermoplastic Edgebanding

- 25.4 mm (1") wide
- 100 m (328') roll (5008)
- 2.4 m (8') length (5009)

PVC Edgebanding

- 23.8 mm (1 5/16") wide
- 236.2 m (600') roll (5050)

SPECIFICATIONS

- Our warranty is applicable on thermoplastic products and does not apply to PVC edgebanding.
- If PVC edgebanding is applied manually, we recommend using a high quality water-based contact cement to avoid damaging adjacent thermoplastic surfaces.



End Panels

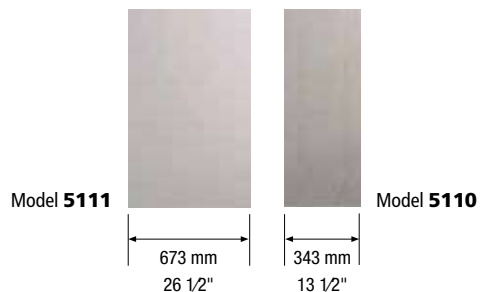

Available dimensions

Model 1 face	Model 2 faces	mm	in.
5110	5116	343 x 2440	13 1/2 x 96
5111	5117	673 x 2440	26 1/2 x 96

SPECIFICATIONS

- All exterior profiles available
- Custom dimensions also available.

TECHNICAL SPECIFICATIONS

Product Properties

Height and width tolerance

- ± 0.5 mm (0.020")

Warp tolerance per linear foot

- $\pm 0,8$ mm (1/32"). Refer to page 47 for recommended hinge holes.

Heat resistance

- 85 °C (185 °F). See page 44 for installation near heat sources.

Product Care and Maintenance

Thermoplastic doors can be easily cleaned with mild soap and water. However, as with any quality product, there are certain precautions you can take to preserve its value.

- Avoid the use of harsh chemicals, such as lacquer thinner, bleach or cleansers containing solvents or abrasives; especially avoid products containing toluene or acetone.
- Avoid bumping or hitting surface with a sharp object, since it could result in a permanent indentation or cut. In the event of abuse, minor surface scratches can sometimes be removed depending on the severity of the damage. The following is recommended:
 - 1) Rub the scratched area with a high grade polishing compound.
 - 2) Polish the area with a caruba based wax.
 - 3) Repair kits are available from paint companies specializing in touch up paints.
- Avoid exposure of doors and drawers to high heat. To ensure against damage to doors or drawers, please do the following:
 - 1) When broiling with oven door open, open doors and drawers of adjacent cabinets to minimize exposure to high heat.
 - 2) Since the door seals on some ranges and ovens allow high heat to escape during the self cleaning cycle, as a precaution, open or remove doors and drawers of adjacent cabinets during the self cleaning cycle. Please read the warranty and instructions for your appliances.
 - 3) Be aware of countertop appliances such as boilers, toasters and toaster ovens that create high heat conditions. They should not be directly under doors of overhead cabinets while in use.

Drawers fronts

We recommend ordering drawers fronts as doors rather than as reduced rails drawer fronts when they are over 228.6 mm (9") high.

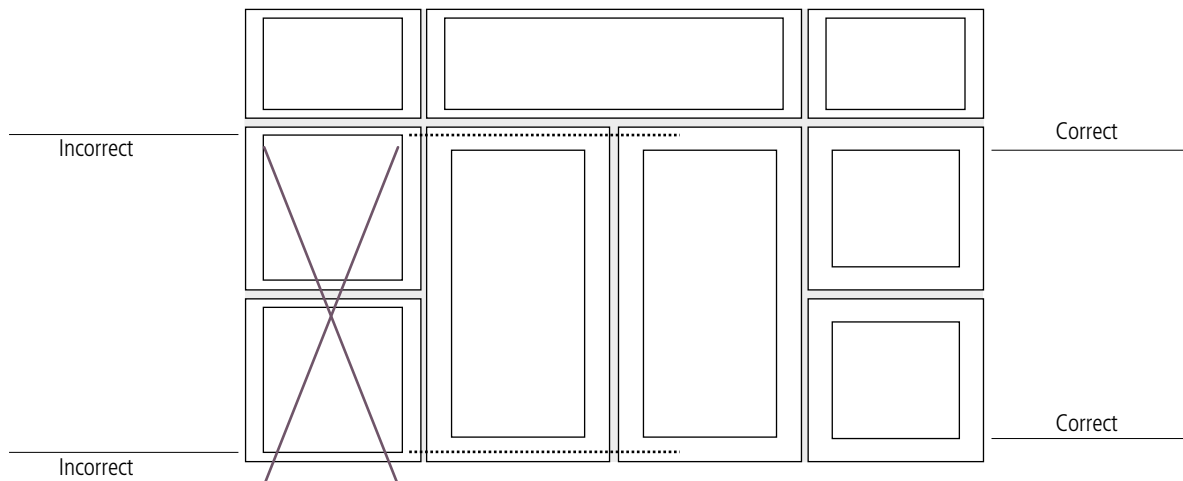

TECHNICAL SPECIFICATIONS

Fingerpull

The descriptive codes for fingerpull location have been simplified. (*) in the new code correspond to the exterior profiles selected. Please replace the asterisk (*) by the exterior profile letter.

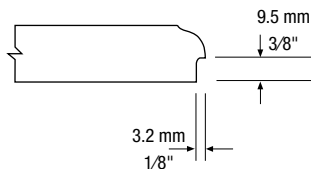

- 1) Can be added to all exterior profiles except **G, H, L, M** and **S**.
- 2) Fingerpulls 4***, *4**, **4* and ***4 will be full length – starting 25.4 mm (1") from one side and ending 25.4 mm (1") from the other side.
- 3) All other fingerpulls will be 101.6 mm (4") wide. Fingerpulls on the corners will be 25.4 mm (1") from the end.

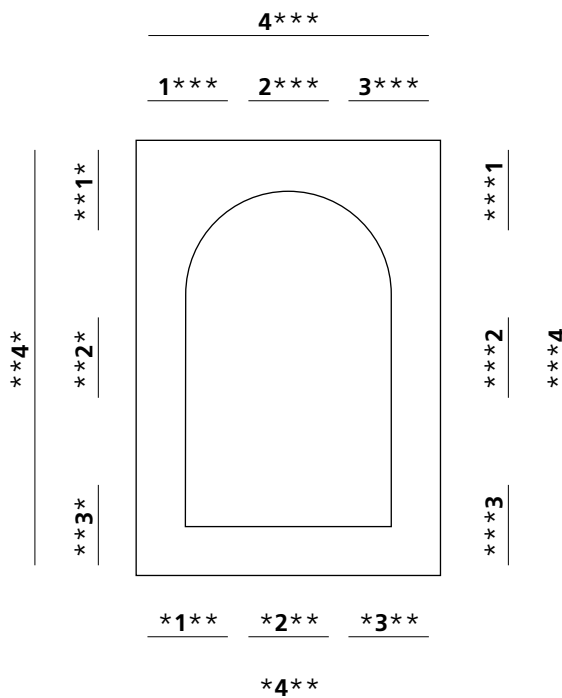

4***	Top full length
*4**	Bottom full length
**4*	Left side full length
***4	Right side full length
1***	Top left
2***	Top centre
3***	Top right
*1**	Bottom left
*2**	Bottom centre
*3**	Bottom right
**1*	Left side top
**2*	Left side centre
**3*	Left side bottom
***1	Right side top
***2	Right side centre
***3	Right side bottom

Quantity and Location of Hinges

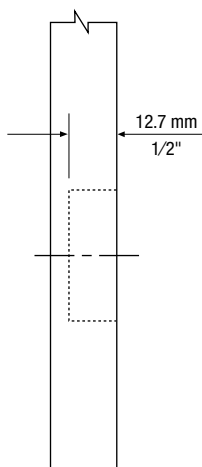
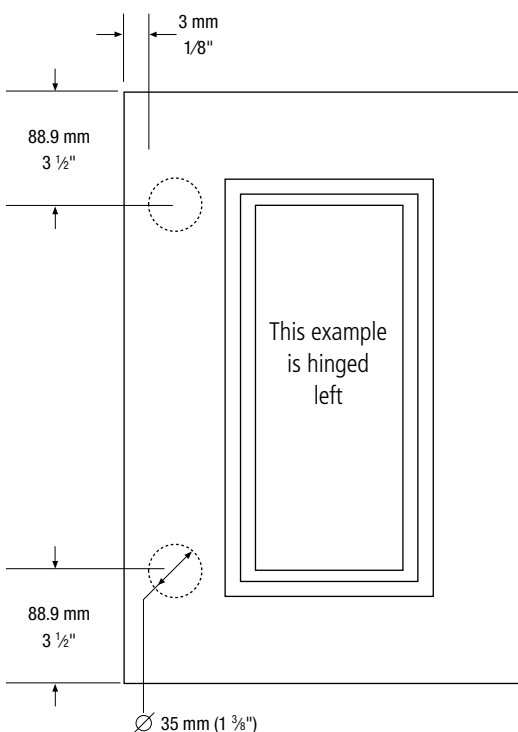

Standard hinge hole diameter: 35 mm (1 3/8")

Standard depth: 12.6 mm (1/2")

Standard location:

- for doors 254 mm (10") and over, 3 mm (1/8") from side and centred at 88.9 mm (3 1/2") from top or bottom edge of the door.
- for doors less than 254 mm (10"), 3 mm (1/8") from side and centred at 63.5 mm (2 1/2") from top or bottom edge of the door.

Note

For doors requiring more than 2 hinges, a drawing indicating actual position of the hinge holes is required.

Door height mm	Door height inches	Number of hinges required
0 to 899.16	0 to 35.4	2
899.17 to 1000.8	35.5 to 39.4	3
1000.9 to 1991.4	39.5 to 78.4	4
1991.5 to 2438.4	78.5 to 96	5

Minimum sizes indicated for each door model must be respected due to hinge clearance considerations.

COLORS AND FINISHES

Color	Description	Color Group	Color Back	Foil with Peel & Stick	Melamine	HPL	Heatshield fillers	Thermo Edge-banding	PVC Edge-banding
A31S	White - Super Matte	B	White - matte	•	Uniboard 555	Arborite V7001-VR			•
A3WT	Weekend Getaway - Textured	B-C	•	•	Tafisa M2003	T2003-VA Arborite W476-EV	•		•
A4WT	Winter Fun - Textured	B-C	•	•	Tafisa M2004	T2004-VA			•
A15WT	Après-ski - Textured	B-C	•	•	Tafisa M2015	T2015-VA Arborite W490-CW	•		•
A24WT	Dalia ambassador - Textured	B-C	•	•	Uniboard K24	Uniboard K24			•
A54WT	Skye - Textured	B-C	•	•	Uniboard H54	Uniboard H54			•
A60WT	Chiffon - Textured	B-C	•	•	Uniboard K60	Uniboard K60			•
A61WT	Silk - Textured	B-C	•	•	Uniboard K61	Uniboard K61			•
A661S	Moon Light - Satin	B-C	•	•	Tafisa L761	Tafisa T761-KR Formica 912-AN			•
B21R	White - Matte	A	White - matte	•	Arauco W400 Panolam S411 Tafisa L080	Wilsonart D427-60	•	•	•
B44W	Chocolate Pear Tree – Matte	B-C	•	•	Tafisa L444			•	•
B54W	Designer White Woodgrain - Matte	A	White - matte	•				•	
B175R	Snow White - Matte	B	White - matte	•	Uniboard 555 Panolam S557	Formica 949-58*	•		•
B920R	Vogue White - Matte	A	White - matte	•	Arauco W920	Panolam SW888	•	•	•
C35S	White - Satin	D	White - matte	•		Pionite SW826-SD	•	•	•
C72R	Antique White - Matte	A-AA	•	•	Panolam S463 Uniboard 810	Formica 932-58 Wilsonart 1572-60 Arborite S463-CA	• • •	•	•
C72S	Antique White - Satin	D-E	•	•	Panolam S463 Uniboard 810	Wilsonart 1572-07	•	•	
C73R	Frosty White - Matte	A	White - matte	•	Arauco W100	Wilsonart 1573-60*	•	•	•
C92W	Érable naturel - Mat	B-C	•	•	Uniboard 992 Panolam W290	Wilsonart 10776-60 Pionite WM791-SD Nevamar WM5528-SD	• •	•	•
F21W	Candlelight - Matte	B-C	•	•	Tafisa L421 Uniboard 262	Pionite WW6001-SD	•	•	•
F432WT	Taction Oak Alabaster - Textured	B-C	•	•	Arauco WF432	Formica WF432-NG	•		•
F434WT	Taction Oak Gibraltar - Textured	B-C	•	•	Arauco WF434	Formica WF434-NG Pionite WY160-TL	• •		•
F435WT	Taction Oak Palomino - Textured	B-C	•	•	Arauco WF435	Formica WF435-NG Arborite W474-LE	•		•
H109L	Grey HG – High Gloss	F	White - matte	•					•
H110L	Taupe HG – High Gloss	F	White - matte	•					•
K02W	Sesame - Satin	B-C	•	•	Uniboard K02	Uniboard K02 Arborite W2009-AW			•
K16S	White - Super Matte	B	White - matte	•	Arauco W100				•
K75S	Violet Grey - Satin	B	White - matte	•					•
K85S	Mysterious Bleu - Satin	B-C	•	•	Arauco SF247	Panolam FB247			•
K168S	Canadien Grey - Satin	B-C	•	•	Uniboard 168	Uniboard 168 Arborite S406-CA	•		•
K233S	Gountlet Grey - Satin	B-C	•	•	Arauco SF233	Panolam FB233	•		•
K241S	Sienna - Satin	B-C	•	•	Arauco SF230	Panolam FB430	•		•
K257S	Verde - Satin	B-C	•	•	Arauco SF257	Panolam FB257	•		•
K464WT	Urban Nomad - Textured	B-C	•	•	Arauco WF464	Wilsonart 8212K-28 Nevamar WU0030-WE	• •		•
K503S	Celadon Green - Satin	B	•	•	Arauco SF251	Panolam FB251	•		•
K636S	Fjord - Satin	B	White - matte	•					•
K961R	Stainless Steel - Matte	D-E	•	•	Uniboard 961 Panolam A60	Uniboard 961		•	•
P488W	Dolce Vita - Matte	B-C	•	•	Tafisa L488	Tafisa T488-SN			•
P489W	Copa Cabana - Matte	B-C	•	•	Tafisa L489	Tafisa T489-SN Arborite W486-CW	•		•

* Stock Prémoulé

Shaded Color code indicates same Color back available. All other colors with white back.
The ultimate responsibility rests solely with the end user with respect to acceptability of these options in specific applications.

COLORS AND FINISHES

Color	Description	Color Group	Color Back	Foil with Peel & Stick	Melamine	HPL	Heatshield fillers	Thermo Edge-banding	PVC Edge-banding
P492W	White Chocolate - Matte	B-C	•	•	Tafisa L492	Tafisa T492-CR Arborite W478-EV	•		•
P501WT	Linear Ash - Textured	B-C	•	•	Arauco WF368	Formica WF368-WR Arborite W496-CW	• •		•
P909R	Black - Matte	A-AA	Black - matte		Uniboard 888	Formica 909-42 * Arborite S405-CA Wilsonart 1595-60 Pionite SE101-SD	• • • •	•	
R32S	Black - Super Matte	B-C	Black - matte	•	Uniboard 888	Formica 909-58 *	•		•
R42L	Black - High Gloss	F	Black - matte	•		Arborite S405-GL Formica 909-90* Wilsonart 1595-F1	• • •		•
R49L	White - High Gloss	F	White - matte	•		Nevamar S7032-GL Wilsonart 1573-F1*	• •	•	•
R80S	Celestine - Satin	B-C	•	•	Uniboard K80	Uniboard K80			•
R81S	Adobe - Super Matte	B	White - matte	•	Uniboard K81	Uniboard K81			•
R82S	White Smoke - Super Matte	B-C	•	•	Uniboard K82	Uniboard K82 Formica 923-58	•	•	•
R83S	Shipshaw - Super Matte	B-C	•	•	Uniboard K83	Uniboard K83		•	•
R89WT	Cosmos - Textured	B-C	•	•	Uniboard K89	Uniboard K89 Formica 8910-NG	•		•
R105S	White - Super Matte	B	White - matte	•	Tafisa L105	Tafisa T105-CR			•
R205W	Tobacco Cherry - Matte	B-C	•	•	Uniboard 205	Uniboard 205 Pionite HP689-SD Nevamar W8371-T	• •	•	•
R207W	Choco Cherry - Matte	B-C	•	•	Uniboard 207 Tafisa L807	Uniboard 207 Tafisa T807-CR Formica 7739-58 Arborite W415-FP	• •	•	•
R232S	Ashen - Satin	B-C	•	•	Arauco SF232	Formica SF232-58 Panolam FB432 Nevamar S2069-T	• • •		•
R237S	Charcoal - Satin	B	White - matte	•	Arauco SF237	Panolam FB237 Nevamar S6054-T	• •		•
R660S	Rain Cloud - Satin	B-C	•	•	Tafisa L760	Tafisa T760-CR			•
R663S	Morning Dew - Satin	B-C	•	•	Tafisa L763	Tafisa T763-CR Arborite S431-CA Wilsonart 1500-60	• •		•
V66WT	Whisper - Textured	B-C	•	•	Uniboard K66	Uniboard K66 Arborite W485-CW	•		•
V67WT	Rumour - Textured	B-C	•	•	Uniboard K67	Uniboard K67 Wilsonart 8208K-16 Wilsonart 7981K-12 Pionite WA110-SD Nevamar WX0075-AB	• • • •		•
V202S	Summer Drops - Satin	B-C	•	•	Tafisa L202	Tafisa T202-CR			•
V285WT	Jazz Silk - Textured	D	White - matte	•		Wilsonart 1595-18 *	•		•
V393WT	Concrete Groovz - Textured	B-C	•	•	Arauco WF393	Arauco WF393-NG	•		
V629R	Ivory - Matte	A-AA	•	•	Tafisa L204	Tafisa T204-CR		•	•
V731V	Matte Luxe Viridian - Velvet	B	White - matte	•					•
V745V	Matte Luxe Black - Velvet	B	White - matte	•		Nevamar S6053-SM	•		•

* Stock Prémoulé

COLORS AND FINISHES

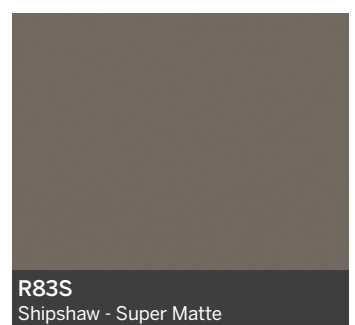
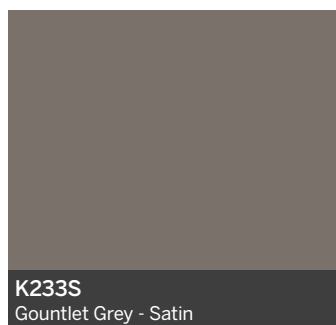
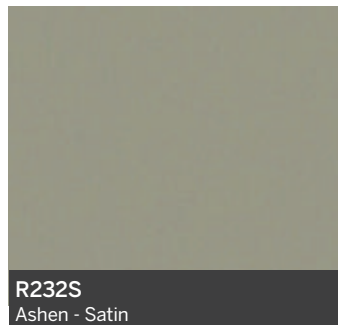
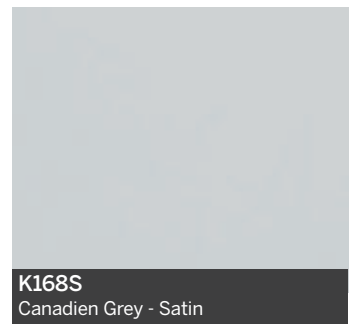
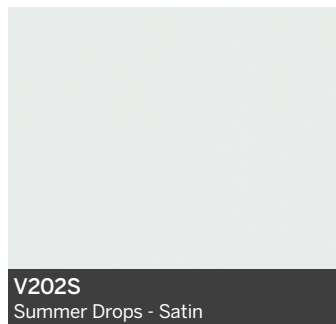
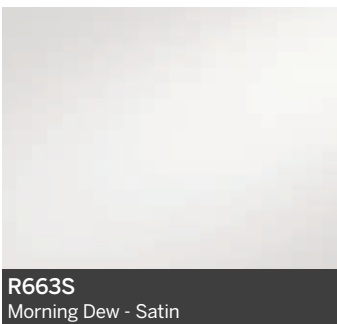
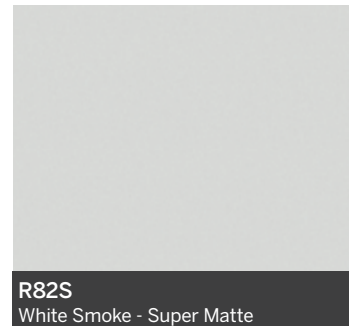
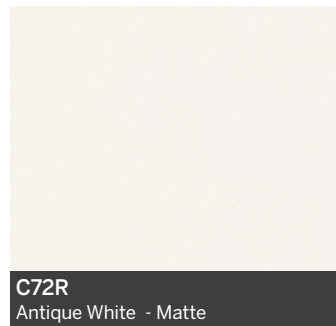
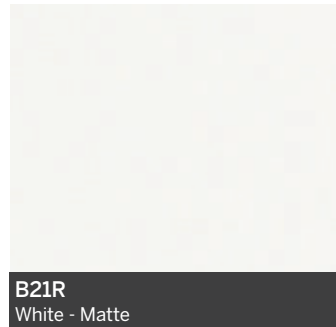
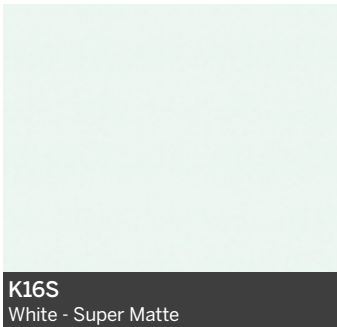
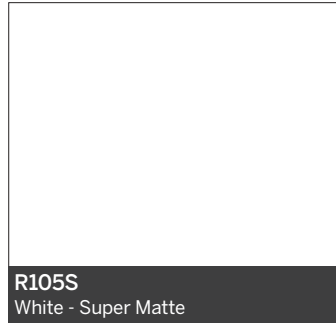

COLORS AND FINISHES

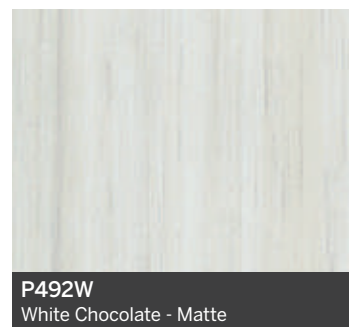
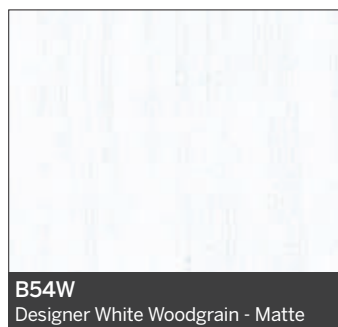
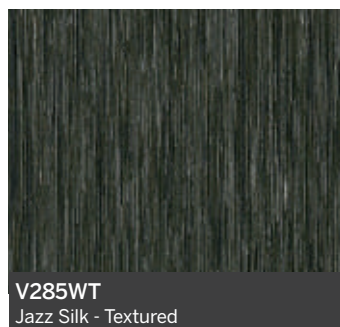
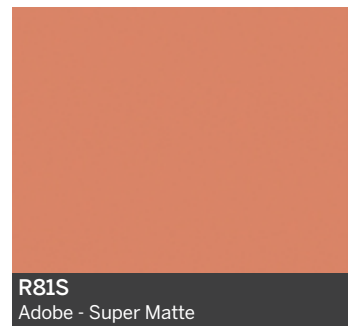
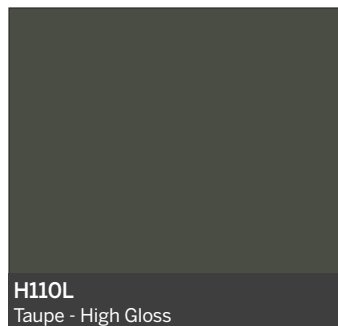
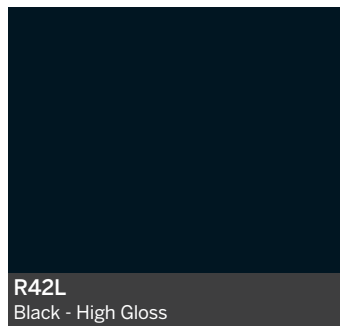
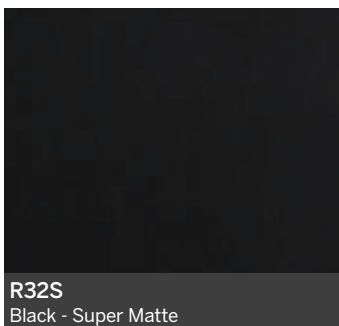
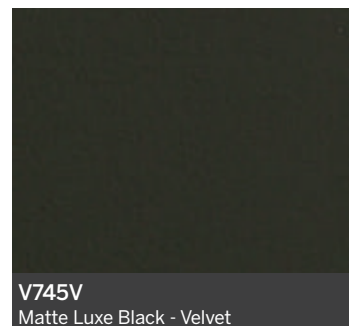
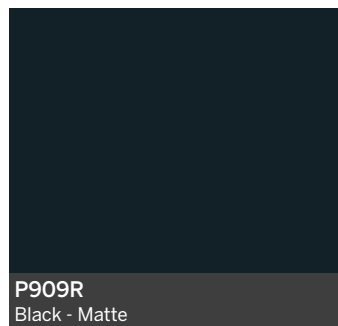
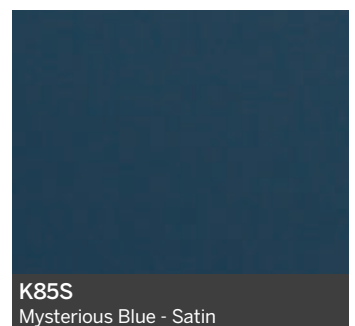
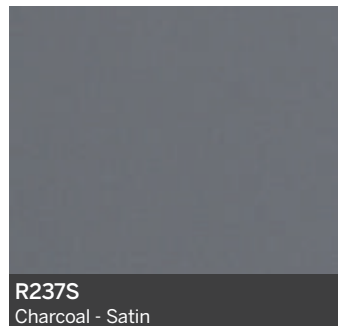
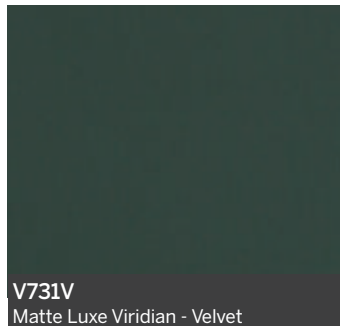
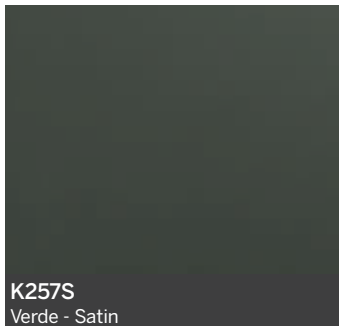
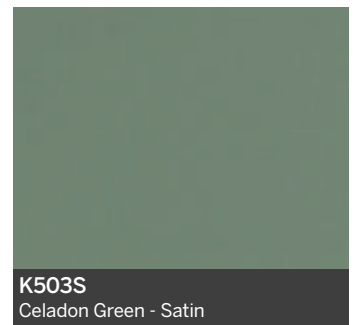
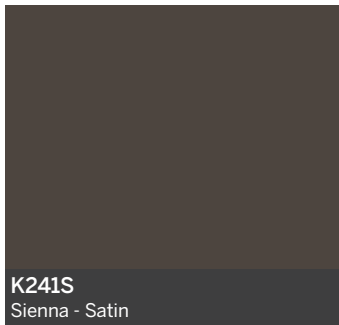

COLORS AND FINISHES

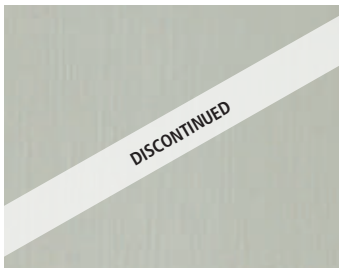

D530WT
Latitude Nord - Textured



A4WT
Winter Fun - Textured



F432W
Taction Oak Alabaster - Satin



A54WT
Skye - Textured



A3WT
Weekend Getaway - Textured



A61WT
Soie - Textured



V66WT
Whisper - Textured



K464WT
Nomade - Textured



P340W
Aria- Matte



V393WT
Concrete Groovz - Textured



A60WT
Mousseline - Textured



K02W
Sesame - Satin



R89WT
Cosmos - Textured



A15WT
Après-ski - Textured



F435WT
Taction Oak Palomino - Textured



V67WT
Rumour - Textured



C92W
Hard Rock Maple - Matte



F21W
Candlelight - Matte



R205W
Tobacco Cherry - Matte



P488W
Dolce Vita - Matte

COLORS AND FINISHES

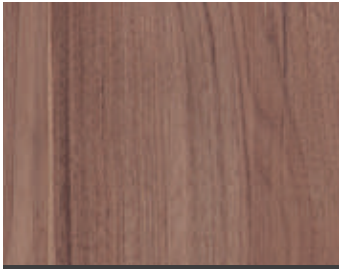

A24WT
Dalia ambassador - Textured



P489W
Copa Cabana - Matte



F434WT
Taction Oak Gibraltar - Textured

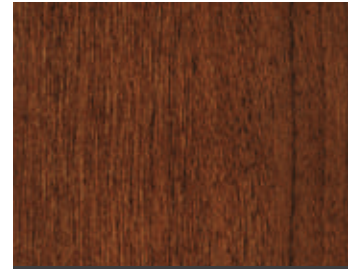

R207W
Choco Cherry - Matte



R74W
Mahogany - Matte



B44W
Chocolate espresso - Woodgrain



P494W
Dark Chocolate - Matte



R477W-DT
Tuxedo - Matte



V392WT
Licorice Groovz - Textured

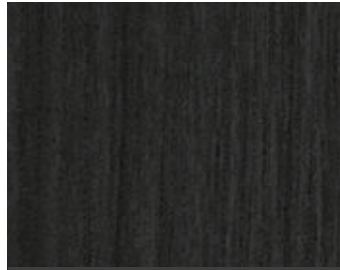

P501WT
Linear Ash - Textured

CERTIFICATE OF
WARRANTY

10 YEARS

APPLICABLE TO THERMOPLASTIC PRODUCTS
Starting on January 1st 2011 (see conditions on reverse)

Distributor

Invoice #

Date of purchase



CERTIFICATE OF WARRANTY

1. General Terms and Conditions

Prémoulé guarantees its thermoplastic products which are distributed and sold through an authorized distributor.

The installation should only be done by an experienced professional. It is also the responsibility of the person installing the product to determine its suitability for a particular application.

Prémoulé guarantees its products against yellowing, delamination or any apparent or hidden defect that might affect their quality or cause premature deterioration. The following conditions apply:

2. Duration

This guarantee is valid for a period of 10 years following the date of purchase.

3. Exclusions

This guarantee does not apply:

3.1 When damages are caused:

- by misuse or abuse of the product by the buyer
- by improper installation or exposure to the elements
- by any modification, transformation, or correction of the product without a written authorization from Prémoulé;
- by improper storage;
- by any indirect damage (including incidentals, special or consequential damages);
- by exposure to a temperature over 85 °C (185 °F)

3.2 To any deterioration of the product resulting from normal wear and tear.

3.3 To any damage or incident relating to the costs of installation and transportation, or any other costs relative to the application of this guarantee.

4. Scope

This guarantee is unassignable and constitutes the only guarantee offered by Prémoulé.

There is no guarantee of merchantability or fitness for specific purposes other than the guarantee detailed above. Prémoulé makes no other guarantee whatsoever, expressed or implied, oral or written.

5. Execution of Guarantee

For the duration of this guarantee, in order to exercise his rights, the buyer shall notify as soon as possible the authorized distributor or PRÉMOULÉ of any defect in the product and shall provide proof of purchase or the back of this present certificate properly completed. The buyer shall not make any repairs before the authorized distributor has had an opportunity to examine the product and its installation.

When this guarantee is applicable, Prémoulé may repair its products, provide replacement products or, at its sole option, offer the reimbursement of the purchase price.

6. Authorized Distributor

Only an authorized Prémoulé distributor may, in compliance with the terms and conditions of this guarantee, assume the obligations contained herein after obtaining prior authorization from Prémoulé. The authorized distributor is not mandated by Prémoulé to modify or extend the scope of this guarantee.

Distributed by

2375, avenue Dalton, bureau 200
Québec (Québec) Canada G1P 3S3

T 418 652-7777 | 1 866 652-7777

F 418 652-7558 | 1 866 652-7558

info@premoule.com

premoule.com

Photography in this leaflet is for illustration purposes only. Actual color may vary slightly due to the printing process. For accurate color selection we recommend that you obtain a product sample.

Prémoulé supports

